

downloaded by
www.radioamatore.info



50/144/430 MHz

**TRIPLE-BAND HEAVY DUTY
SUBMERSIBLE TRANSCEIVER**

VX-7R

OPERATING MANUAL



VERTEX STANDARD CO., LTD.

4-8-8 Nakameguro, Meguro-Ku, Tokyo 153-8644, Japan

VERTEX STANDARD

US Headquarters

17210 Edwards Rd., Cerritos, CA 90703, U.S.A.

International Division

8350 N.W. 52nd Terrace, Suite 201, Miami, FL 33166, U.S.A.

YAESU EUROPE B.V.

P.O. Box 75525, 1118 ZN Schiphol, The Netherlands

YAESU UK LTD.

Unit 12, Sun Valley Business Park, Winnall Close
Winchester, Hampshire, SO23 0LB, U.K.

VERTEX STANDARD HK LTD.

Unit 5, 20/F., Seaview Centre, 139-141 Hoi Bun Road,
Kwun Tong, Kowloon, Hong Kong

Contents

Introduction	1	Memory Mode	45
Controls & Connections	2	Regular Memory Operation	46
Display Icons & Indicators	3	Memory Storage	46
Keypad Function	4	Storing Independent Transmit Frequencies ("Odd Split")	46
Accessories & Options	6	Memory Recall	47
Installation of Accessories	7	HOME Channel Memory	47
Antenna Installation	7	Labeling Memories	48
How to Install the Quick Draw Belt Clip	8	Memory Offset Tuning	49
Installation of FNB-80LI Battery Pack	8	Masking Memories	50
Installation of FBA-23 (option) Alkaline Battery Case	9	Memory Group Operation	51
Battery Life Information	10	Moving Memory Data to the VFO	52
AC Operation Using NC-72	10	Memory Only Mode	52
Interface of Packet TNCs	11	Hyper Memory Operation	53
Operation	12	One-Touch Memory Operation	54
Switching Power On and Off	12	Sort-wave Broadcast Station Memory Channels	55
Adjusting the Volume Level	12	VHF Marine Memory Channels	56
Squelch Adjustment	13	Scanning	57
Selecting the Operating Band	14	VFO Scanning	58
Selecting the Frequency Band	15	Memory Scanning	58
Frequency Navigation	16	Temporary Memory Skip	59
Audio Muting	17	How to Skip (Omit) a Channel During Memory Scan Operation	59
BAND Link	17	Preferential Memory Scan	60
Transmission	17	Programmable (Band Limit) Memory Scan (PMS) "Priority Channel" Scanning (Dual Watch)	61
Changing the Transmitter Power Level	18	Automatic Lamp Illumination on Scan Stop	62
VOX Operation	19	Band Edge Beeper	62
AM Broadcast Reception	20	Spectrum Analyzer Operation	63
AM Aircraft Reception	20	Smart Search Operation	64
FM Broadcast/TV Audio Reception	21	Channel Counter Operation	66
Weather Broadcast Reception	22	Internet Connection Feature	67
Keyboard Locking	23	Sensor Mode	68
Keypad/LCD Illumination	24	Sensor Mode Option	69
Disabling the Keypad Beeper	24	Clock Set	69
Advanced Operation	25	Selecting the Wave Form Display	70
Setting the Frequency Display Image Size	25	Selecting the Unit of Temperature Display	70
Changing the Channel Steps	25	Selecting the Unit of Atmospheric Pressure Meter (Barometer)	70
Changing the Operating Mode	26	Correcting the Atmospheric Pressure Meter (Barometer Offset)	70
Repeater Operation	27	Selecting the Unit of Altimeter	71
CTCSS Operation	30	Correcting the Altimeter Setting (Altimeter Offset)	71
DCS Operation	31	Timer Operation	72
Tone Search Scanning	32	Display Customization	73
CTCSS/DCS Bell Operation	33	Icon Mode	73
Split Tone Operation	33	Icon Selection	73
Tone Calling (1750 Hz)	34	Icon Editor	74
ARTS (Automatic Range Transponder System)	35	Power-Off Display Mode	75
DTMF Operation	38	S-and TX Power Meter Symbols	76
Emergency Channel Operation	39	Font Editor	77
ATT (Front End Attenuator)	40	Display Contrast	78
Receive Battery Saver Setup	40	Display Dimmer	78
TX Battery Saver	41	STROBE Customization	79
Disabling the "STROBE"	41	Reset Procedures	80
Automatic Power-Off (APO) Feature	42	Cloning	81
Transmitter Time-Out Timer (TOT)	42	Set Mode	82
Busy Channel Lock-Out (BCLO)	43	Installation of the SU-1	97
MIC Monitor	43	Specifications	98
Changing the TX Deviation Level	44	Appendix	100

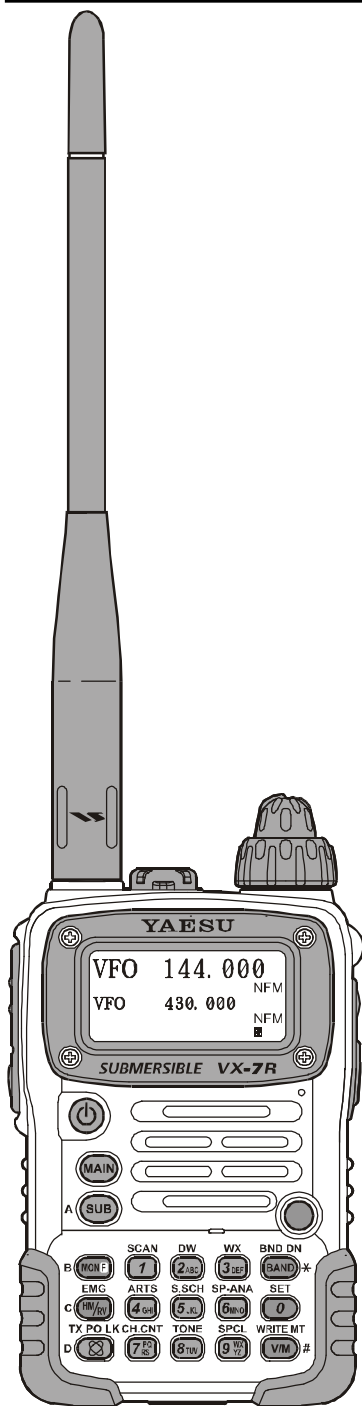

The **VX-7R** is a miniature 3-band FM transceiver with extensive receive frequency coverage, providing leading-edge features for VHF and UHF two-way amateur communications, along with unmatched monitoring capability.

The **VX-7R**'s small size allows you to take it anywhere – hiking, skiing, or while walking around town – and its operating flexibility brings the user many avenues of operating enjoyment. Besides 50, 144, and 430 MHz transceive operation, the **VX-7R** provides 222 MHz QRP (0.3 Watts) transceive operation, receive coverage of the AM (MF) and FM broadcast bands, HF Shortwave Bands up to 16 MHz, VHF and UHF TV bands, the VHF AM aircraft band, and a wide range of commercial and public safety frequencies! Dual In-band Receive (V/V and U/U) lets you keep track of two active frequencies. And the optional Barometer pressure Sensor Unit provides readout of barometric pressure and altitude while mountain climbing or hiking, and it also generates a Weather Forecast based on measured data.

The transmitter section provides 5 Watts of clean power output on the FM operation on the 50 MHz, 144 MHz, and 430 MHz bands with the supplied **FNB-80LI** Battery Pack, and 0.3 Watts output on 222 MHz, and 1 Watt of carrier output for AM operation on 50 MHz. Both CTCSS and DCS tone signaling formats are built into the **VX-7R**, in addition to Yaesu's exclusive ARTS™-(Auto-Range Transponder System), which “beeps” the user when you move out of communications range with another ARTS™-equipped station.

We appreciate your purchase of the **VX-7R**, and encourage you to read this manual thoroughly, so as to learn about the many exciting features of your exciting new Yaesu hand-held transceiver!

CONTROLS & CONNECTIONS

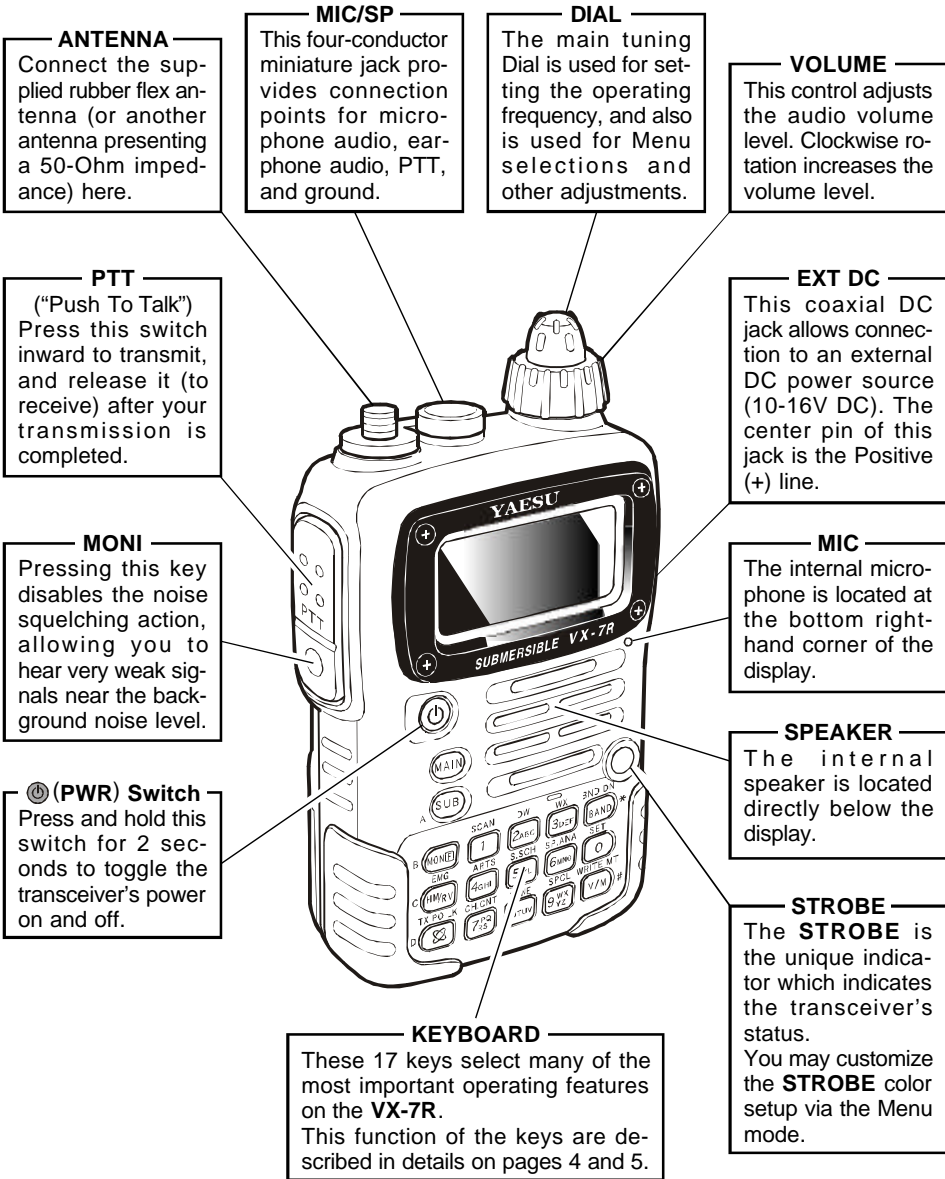

DISPLAY ICONS & INDICATORS

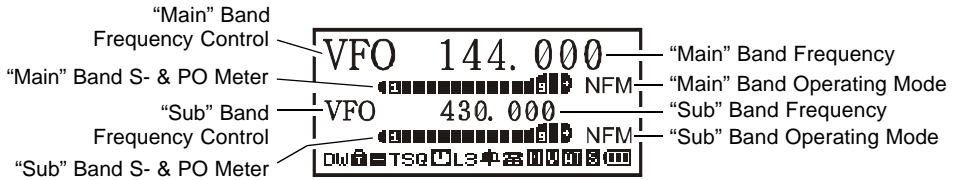

FREQUENCY CONTROL

VFO: VFO Mode (page 15)
MR: Memory Mode (page 45)
MT: Memory Tune Mode (page 49)
PMS: Programable Memory Scan Mode (page 61)
WX: Weather Channel (page 22)
Sea: Marine Channel (page 56)
HYP: Hyper Memoy Mode (page 53)
OTM: One Touch Memory Mode (page 54)
LST: Short-wave Broadcast StationMemory (page 55)













OPERATING MODE

NFM: FM
WFM: Wide FM
AM: AM











ICON

: Dual Watch Active (page 61)
: Key Lock Active (page 23)
: Repeater Shift Direction (page 27)
: Minus (-) Shift
: Plus (+) Shift
: Odd Splits
TSQ: CTCSS/DCS Operation (page 30)
T: Tone Encoder
TSQ: Tone Squelch
DCS: Digital Code Squelch (DCS)
T-D: TX: Tone Encoder, RX: DCS Decoder
D-T: TX: DCS Encoder, RX: Tone Decoder
D: DCS Encoder
: Automatic Power-Off Active (page 42)
L3: Low TX Power Selected (page 18)
No Icon: High Power
L3: Low Power 3
L2: Low Power 2
L1: Low Power 1
: Bell Alarm Active (page 33)
: DTMF Autodialer Active (page 39)
: Audio Mute Active (page 17)
: VOX Active (page 18)
: RF Front-end Attenuator Active (page 40)
: Battery Saver Active (page 40)
: Low Battery! (page 10)

KEYPAD FUNCTIONS

			
Press Key	Activates the "Alternate" key Function	Frequency entry digit "1"	Frequency entry digit "2"
Press + 	No Action	Activates the Scanner	Activates the Dual Watch Feature
Press and Hold Key	Activates the "Memory Write" mode (for memory channel storage)	Store the current setting into the Hyper Memory "1"	Store the current setting into the Hyper Memory "2"
			
Press Key	Reverses the transmit and receive frequencies while working through a repeater	Frequency entry digit "4"	Frequency entry digit "5"
Press + 	Switches operation to the "Home" (favorite frequency) Channel	Activates the ARTS Feature	Activates the Smart Search™ Feature
Press and Hold Key	Activates the EMERGENCY Function	Store the current setting into the Hyper Memory "4"	Store the current setting into the Hyper Memory "5"
			
Press Key	Activates the Internet Connection Feature	Frequency entry digit "7"	Frequency entry digit "8"
Press + 	Select the desired transmit power output	Activates the Channel Counter Feature	Activates the CTCSS or DCS Operation
Press and Hold Key	Activates the Key Lock Feature	Store the current setting into the Hyper Memory "7"	Store the current setting into the Hyper Memory "8"

KEYPAD FUNCTIONS

			
Frequency entry digit "3"	Moves operation to the next-highest frequency band	Press Key	Switches the "Upper" frequency to be the "Operating" (TX) Band
Recall the "Weather" broadcast channel bank	Moves operation to the next-lowest frequency band	Press + 	Switches the "Upper" frequency display between the "Large Character" and "Small Character" mode
Store the current setting into the Hyper Memory "3"	Moves operation to the next-highest frequency band	Press and Hold Key	Activates the Dual Receive Feature
			
Frequency entry digit "6"	Frequency entry digit "0"	Press Key	Switches the "Lower" frequency to be the "Operating" (TX) Band
Activates the Spectrum Analyzer (Spectra-Scope™) Feature	Enter the "Set" (Menu) Mode	Press + 	Switches the "Lower" frequency display between the "Large Character" and "Small Character" mode
Store the current setting into the Hyper Memory "6"	Store the current setting into the Hyper Memory "0"	Press and Hold Key	Activates the Dual Receive Feature
			MONI Key
Frequency entry digit "9"	Switches frequency control between the VFO and Memory System	Press Key	USA Version: Disables the Noise and Tone Squelch System EXP Version: Activates T.CALL (1750 Hz) for repeater access
Enters the "Special Memory" mode	No Action	Press + 	USA Version: Enters the Squelch level setting mode EXP Version: Activates T.CALL (1750 Hz) for repeater access
Store the current setting into the Hyper Memory "9"	Activates the "Memory Tune" mode while in the Memory Recall mode	Press and Hold Key	No Action

ACCESSORIES & OPTIONS

ACCESSORIES SUPPLIED WITH THE VX-7R

- FNB-80LI** Battery Pack (7.4V/1,300mAh)
- NC-72B/C** Battery Charger
- Quick Draw Belt Clip
- Hand Strap
- Antenna
- Operating Manual
- Warranty Card

AVAILABLE OPTIONS FOR YOUR VX-7R

- ① **CSC-88** Soft Case
- ② **CD-15A** Rapid Charger (requires NC-72B/C)
- ③ **FBA-23** 2 x "AA" Cell Battery Case (batteries not supplied)
- ④ **FNB-80LI** Battery Pack (7.4V/1,300 mAh)
- ⑤ **E-DC-5B** DC Cable w/Noise Filter
- ⑥ **NC-72B/C** Battery Charger
- ⑦ **E-DC-6** DC Cable; plug and wire only
- ⑧ **CT-91** Microphone Adapter
- ⑨ **VC-27** Earpiece/Microphone
- ⑩ **MH-57A4B** Speaker/Microphone
- ⑪ **CMP460A** Waterproof Speaker/Microphone
- ⑫ **CN-3** BNC-to-SMA Adapter
- ⑬ **SU-1** Barometric Pressure Sensor Unit

Availability of accessories may vary. Some accessories are supplied as standard per local requirements, while others may be unavailable in some regions. Consult your Yaesu Dealer for details regarding these and any newly-available options. Connection of any non-Yaesu-approved accessory, should it cause damage, may void the Limited Warranty on this apparatus.

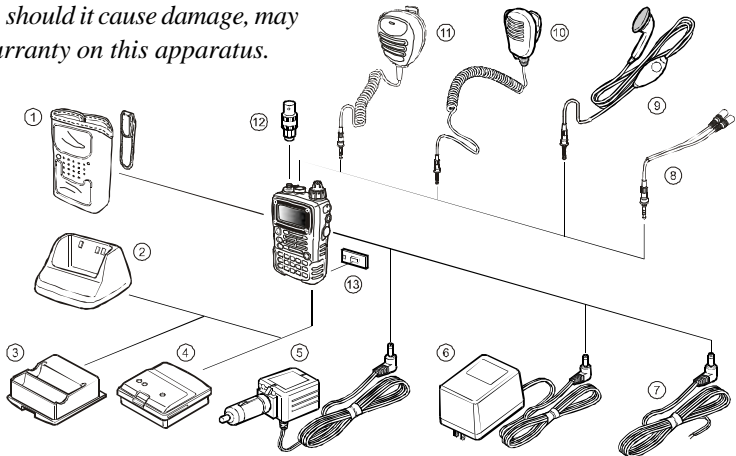

INSTALLATION OF ACCESSORIES

ANTENNA INSTALLATION

The supplied antenna provides good results over the entire frequency range of the transceiver. However, for enhanced base station medium-wave and shortwave reception, you may wish to connect an external (outside) antenna.

The supplied antenna consists of two sections: the “Base Antenna” (used for operation above 50 MHz), and the “Extender Element” (used for monitoring of frequencies below 50 MHz).

To install the supplied antenna

Hold the bottom end of the antenna, then screw it onto the mating connector on the transceiver until it is snug. Do not over-tighten by use of extreme force.

When operating the **VX-7R** on the 50 MHz band and lower frequencies, disconnect the antenna cap from the base antenna, then screw the Extender Element onto the Antenna Base. Of course, the **VX-7R** may be operated on frequencies higher than the 50 MHz band while the Extender Element is still attached onto the Antenna Base.

Notes:

- Never transmit without having an antenna connected.
- When installing the supplied antenna, never hold the upper part of the antenna while screwing it onto the mating connector on the transceiver.
- If using an external antenna for transmission, ensure that the SWR presented to the transceiver is 1.5:1 or lower.
- Take care not lose the antenna cap when removing it from the Base Antenna.

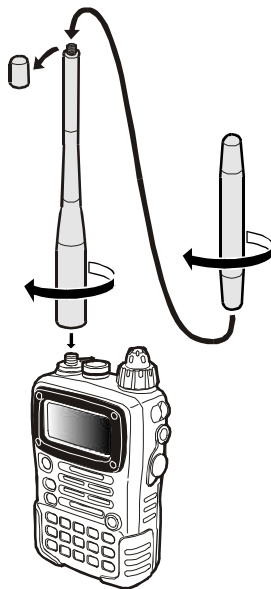

HAND STRAP INSTALLATION

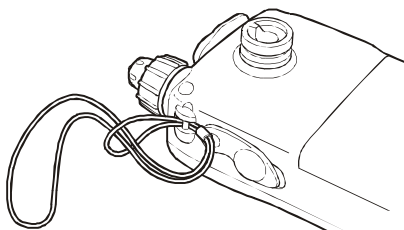

INSTALLATION OF ACCESSORIES

HOW TO INSTALL THE QUICK DRAW BELT CLIP

1. Connect the hanger to the rear of the **VX-7R**, with the notch pointing directly up, using the supplied screw (**Figure 1**). Use only the screw included with the clip to mount the clip to the back of the **VX-7R**!
2. Clip the Quick-Draw Belt Clip onto your belt (**Figure 2**).
3. To install the **VX-7R** into the Quick-Draw Belt Clip, align the hanger with the Quick-Draw Belt Clip, and slide the **VX-7R** into its slot until a click is heard (**Figure 3**).
4. To remove the **VX-7R** from the Quick-Draw Belt Clip, rotate the **VX-7R** 180 degrees, then slide the **VX-7R** out from the Quick-Draw Belt Clip (**Figure 4**).

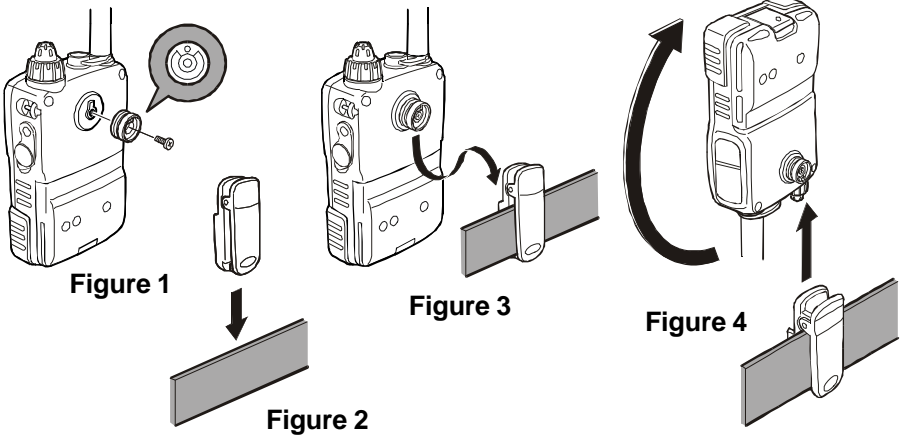

INSTALLATION OF FNB-80LI BATTERY PACK

The **FNB-80LI** is a high-performance Lithium-Ion battery providing high capacity in a very compact package. Under normal use, the **FNB-80LI** may be used for approximately 300 charge cycles, after which operating time may be expected to decrease. If you have an old battery pack which is displaying capacity which has become diminished, you should replace the pack with a new one.

1. Install the **FNB-80LI** as shown in the illustration.
2. Close the Battery Pack Latch on the bottom of the radio.

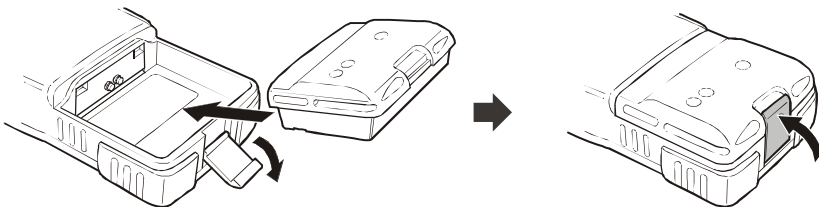

INSTALLATION OF ACCESSORIES

INSTALLATION OF FNB-80LI BATTERY PACK

If the battery has never been used, or its charge is depleted, it may be charged by connecting the **NC-72B/C** Battery Charger, as shown in the illustration, to the **EXT DC** jack. If only 12 ~ 16 Volt DC power is available, the optional **E-DC-5B** or **E-DC-6** DC Adapter (with its cigarette lighter plug) may also be used for charging the battery, as shown in the illustration.

The display will indicate “now charging” while the battery is being charged. When charging is finished, the display will change to indicate “complete” and the **STROBE** indicator will glow blue.

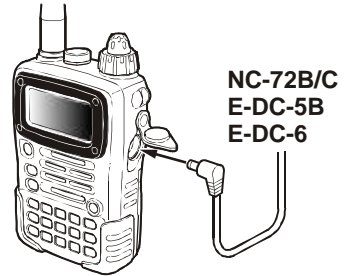

INSTALLATION OF FBA-23 ALKALINE BATTERY CASE (OPTION)

The optional **FBA-23** Battery Case allows receive monitoring using two “AA” size Alkaline batteries. Alkaline batteries can also be used for transmission in an emergency, but power output will only be selectable 300 mW and 50 mW, and battery life will be shortened dramatically.

To Install Alkaline Batteries into the FBA-23

1. Slide the batteries into the **FBA-23** as shown in the illustration, with the Negative [-] side of the batteries touching the spring connections inside the **FBA-23**.
2. Open the Battery Pack Latch on the bottom of the radio.
3. Install the **FBA-23** as shown in the illustration, with the [+] side facing the bottom of the transceiver.
4. Close the Battery Pack Latch on the bottom of the radio.

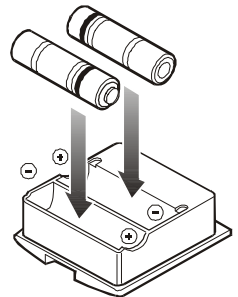

The **FBA-23** does not provide connections for charging, since Alkaline cells cannot be recharged. Therefore, the **NC-72B/C**, **E-DC-5B**, or **E-DC-6** may safely be connected to the **EXT DC** jack when the **FBA-23** is installed.

Notes:

- The **FBA-23** is designed for use only with AA-type Alkaline cells.
- If you do not use the **VX-7R** for a long time, remove the Alkaline batteries from the **FBA-23**, as battery leakage could cause damage to the **FBA-23** and/or the transceiver.

INSTALLATION OF ACCESSORIES

BATTERY LIFE INFORMATION

When the battery charge is almost depleted, a “Low Voltage” indicator will appear on the display. When this icon appears, it is recommended that you charge the battery soon.

Operating Band	Battery Life (Approx.)		Low Voltage Indicator
	FNB-80LI	FBA-23	
50 MHz ⁽¹⁾	6.5 hours	7.0 hours	FNB-80LI: No icon: Fully battery power ▣: Enough battery power ▣: Lower battery power ▣: Poor battery power ▣: Nearing depletion ▣(w/Blink): Prepare to charge the battery FBA-23: ▣: Enough battery power ▣(w/Blink): Prepare to replace the battery
144 MHz ⁽¹⁾	6.0 hours	6.5 hours	
430 MHz ⁽¹⁾	5.5 hours	6.0 hours	
Other Band ⁽²⁾	15 hours	15 hours	

(1) TX 6 sec., RX 6 sec. and Squelched 48 sec.

(2) Continuous signal reception

The current battery voltage can be displayed manually on the LCD, by following the instructions on page 68.

Battery capacity may be reduced during extremely cold weather operation. Keeping the radio inside your parka may help preserve the full charge capacity.

AC OPERATION USING NC-72B/C (RECEIVING ONLY)

The **VX-7R** may be operated from your house current by use of the supplied **NC-72B/C** Battery Charger. The **NC-72B/C** should only be used for reception, because it is not capable of supplying sufficient current to support transmission.

To use the **NC-72B/C**, turn the transceiver off, then plug the miniature connector of the Battery Charger into the **EXT DC** jack on the side of the radio. Now plug the Battery Charger into the wall outlet. You may now turn on the transceiver.

downloaded by
www.radioamatore.info

INTERFACE OF PACKET TNCs

The **VX-7R** may be used for Packet operation, using the optional **CT-91** microphone adapter (available from your Yaesu dealer) for easy interconnection to commonly-available connectors wired to your TNC. You may also build your own cable using a four-conductor miniature phone plug, per the diagram below.

The audio level from the receiver to the TNC may be adjusted by using the **VOLUME** knob, as with voice operation. The input level to the **VX-7R** from the TNC should be adjusted at the TNC side; the optimum input voltage is approximately 5 mV at 2000 Ohms.

Be sure to turn the transceiver and TNC off before connecting the cables, so as to prevent voltage spikes from possibly damaging your transceiver.

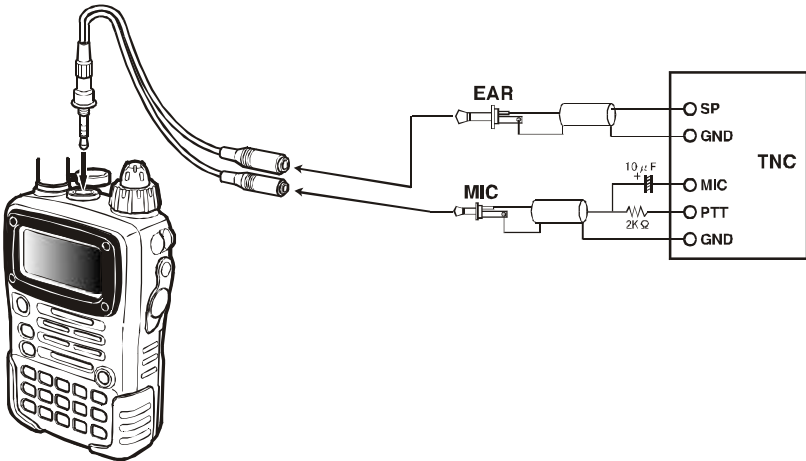



downloaded by
www.radioamatore.info

OPERATION



Hi! I'm R. F. Radio, and I'll be helping you along as you learn the many features of the VX-7R. I know you're anxious to get on the air, but I encourage you to read the "Operation" section of this manual as thoroughly as possible, so you'll get the most out of this fantastic new transceiver. Now. . .let's get operating!

SWITCHING POWER ON AND OFF

1. Be sure the battery pack is installed, and that the battery is fully charged. Connect the antenna to the top panel **ANTENNA** jack.
2. Press and hold in the  (**PWR**) switch (on the left side of the front panel) for 2 seconds. Two beeps will be heard when the switch has been held long enough, and the opening message will appear on the display, then frequency display will appear. After another two seconds, the receive-mode Battery Saver function will become active, unless you have disabled it (see page 40).
3. To turn the **VX-7R** off, press and hold in the  (**PWR**) switch again for 2 seconds.

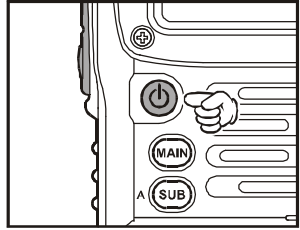

If you don't hear the two "Beep" tones when the radio comes on, the Beeper may have been disabled via the Menu system. See page 24, which tells you how to reactivate the Beeper.

ADJUSTING THE VOLUME LEVEL

Rotate the **VOLUME** control (inner knob) to set the desired audio level. Clockwise rotation increases the volume level.

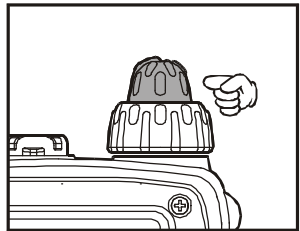

downloaded by
www.radioamatore.info

24-hour Clock

The **VX-7R** has a 24-hour clock with a calendar which covers all dates from January 1, 2000 through December 31, 2099. Set the clock according to the "Clock Set" column on page 69.

SQUELCH ADJUSTMENT

The **VX-7R**'s Squelch system allows you to mute the background noise when no signal is being received. Not only does the Squelch system make "standby" operation more pleasant, it also significantly reduces battery current consumption.

The Squelch system may be adjusted independently for the FM and Wide-FM (FM Broadcast) modes.

1. Press the **(MONI)** key, then press the **MONI** switch on the left side of the radio. This provides a "Short-cut" to Menu Item (**Basic Setup #1: SQL NFM**) or Menu Item (**Basic Setup #2: SQL WFM**).
2. Now, press the **(MAIN)** or **(SUB)** key to set the background noise is just silenced (typically at a setting of about "3" or "4" on the scale); this is point of maximum sensitivity to weak signals.
3. When you are satisfied with the Squelch threshold setting, press the **PTT** key momentarily to save the new setting and exit to normal operation.
4. You may also adjust the Squelch setting by using the "Set" (Menu) mode. See page 82 for details.

Basic Setup	:	1
SQL NFM		
LEVEL		1



1) The Squelch level may be set on the "Main" and "Sub" bands separately.
2) If you're operating in an area of high RF pollution, you may need to consider "Tone Squelch" operation using the built-in CTCSS Decoder. This feature will keep your radio quiet until a call is received from a station sending a carrier which contains a matching (subaudible) CTCSS tone. Or if your friends have radios equipped with DCS (Digital Coded Squelch) like your VX-7R has, try using that mode for silent monitoring of busy channels.

downloaded by
www.radioamatore.info

OPERATION

SELECTING THE OPERATING BAND

In the factory default configuration, the **VX-7R** operates in the “Dual Receive” mode.

During Dual Receive operation, the “Main” band frequency will be displayed on the upper side of the LCD, and the “Sub” band frequency will be displayed on the lower side, with the “Operating” band (the band on which transmission and band/frequency change are possible) being indicated in *large* characters, and “Receive only” band being indicated in *small* characters.

To switch the “Operating” band, press the **(MAIN)** key momentarily to engage the “Main” band frequency as the “Operating” band. Alternatively, press the **(SUB)** key momentarily to engage the “Sub” band frequency as the “Operating” band, described previously.

Press and hold in the **(MAIN)** or **(SUB)** key for 1/2 seconds to switch to Mono Band Operation with a *double-size* display.

During Mono band operation, you may press the **(MON F)** key, then press the **(MAIN)**/**(SUB)** key, to change the display to show *only large* characters.



The “Sub” band frequency may only be used on the amateur bands, even if it is designated as the “Operating” band. Extended receiver coverage is only possible on the “Main” band.

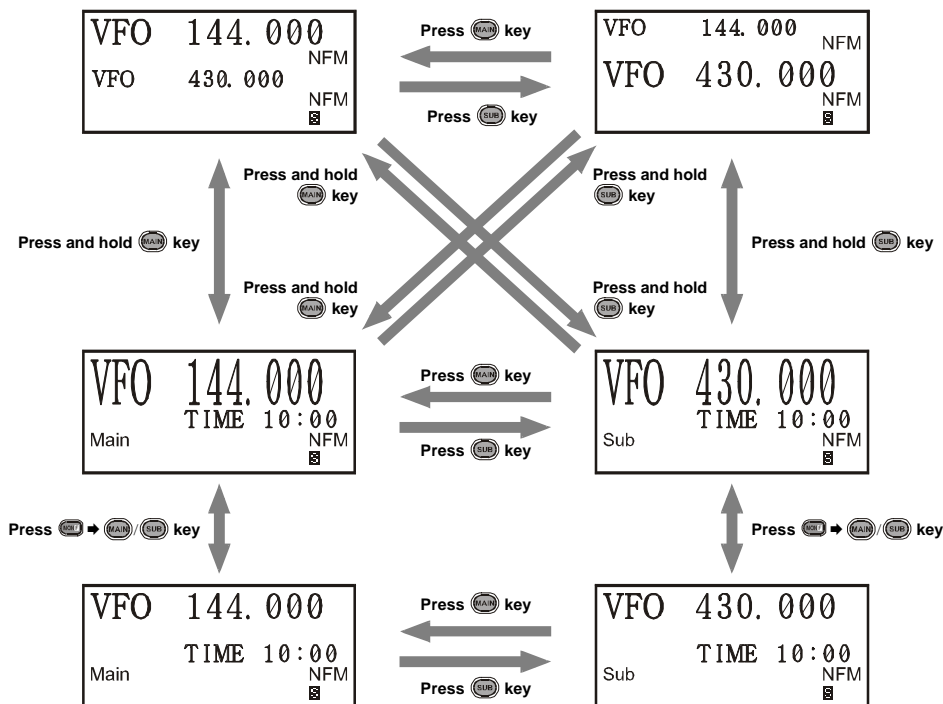







SELECTING THE FREQUENCY BAND

The **VX-7R** covers an incredibly wide frequency range, over which a number of different operating modes are used. Therefore, the **VX-7R**'s frequency coverage has been divided into different operating bands, each of which has its own pre-set channel steps and operating modes. You can change the channel steps and operating modes later, if you like (see page 25).

BAND	"Main" Band	"Sub" Band
BC Band	0.5-1.8 MHz	—
SW Band	1.8-30 MHz	—
FM BC Band	59-108 MHz (88-108 MHz)	—
AIR Band	108-137 MHz	—
VHF-TV Band	174-222 MHz	—
Action Band 1	225-420 MHz	—
UHF TV Band	470-729 MHz (470-800 MHz)	—
Action Band 2	800-999 MHz	—
50 MHz Ham Band	30-59 MHz (30-88 MHz)	50-54 MHz
144 MHz Ham Band	137-174 MHz	140-174 MHz
222 MHz Ham Band	222-225 MHz (—)	—
430 MHz Ham Band	420-470 MHz	420-470 MHz

() : EXP Version

To Change Operating Bands

1. Press the  key repetitively. You will see the LCD indication move toward a higher frequency band each time you press the .
2. If you wish to move the operating band selection downward (toward *lower* frequencies), press the  key first, then press the .
3. The **VX-7R** uses a dual VFO system (described previously). To switch TX/RX operation from the "Main" VFO to the "Sub" VFO instantly, press the  key momentarily. Pressing the  key will return the **VX-7R** to the "Main" VFO. The frequency band bearing the "Large" characters is the band on which transmission is possible; the band designated by "Small" characters may only be used for reception.
4. Once you have selected the desired band, you may initiate manual tuning (or scanning) per the discussions on the next page.

Dual Receive Notice

The **VX-7R** may receive very strong signals on the Image frequency, and/or the receiver sensitivity may be somewhat reduced by the combination of the "Main" and "Sub" band frequencies while Dual Receive operation is engaged.

If you experience interference that you suspect may be coming in via an "Image" path, you may calculate the possible frequencies using the formulas below. This information may be used in the design of effective countermeasures such as traps, etc.

- $3.579545 \text{ MHz} \times n$ ○ $11.7 \text{ MHz} \times n$ (n is an integer: 1, 2, 3, ...)
- "Main" band freq. = ("Sub" band freq. \pm 46.35 MHz) $\times n$
- "Sub" band freq. = ("Main" band freq. \pm 47.25 MHz) $\times n$ (@ "Main band = NFM)
- "Sub" band freq. = ("Main" band freq. \pm 45.8 MHz) $\times n$ (@ "Main band = WFM)

OPERATION

FREQUENCY NAVIGATION

The **VX-7R** will initially be operating in the “VFO” mode, as just described. This is a channelized system which allows free tuning throughout the currently-selected operating band.

Three basic frequency navigation methods are available on the **VX-7R**:

1) Tuning Dial (Outer ring of dual control on Top Panel)

Rotation of the **DIAL** allows tuning in the pre-programmed steps established for the current operating band. Clockwise rotation of the **DIAL** causes the **VX-7R** to be tuned toward a higher frequency, while counter-clockwise rotation will lower the operating frequency.

If you press the **(MON F)** key momentarily, then rotate the **DIAL**, frequency steps of 1 MHz will be selected. This feature is extremely useful for making rapid frequency excursions over the wide tuning range of the **VX-7R**.

2) Direct Keypad Frequency Entry

The desired operating frequency may be entered directly from the keypad.

The operating mode will automatically be set once the new frequency is entered via the keypad.

To enter a frequency from the keypad, just press the numbered digits on the keypad in the proper sequence. There is no “Decimal point” key on the **VX-7R**, so if the frequency is below 100 MHz (e.g. 15.150 MHz), any required leading zeroes must be entered. However, there is a short-cut for frequencies ending in zero - press the **(V/M)** key after the last non-zero digit.

Examples:

To enter 146.520 MHz, press **(SCAN 7)** → **(ARTS 4 MHz)** → **(SPANA 6 MHz)** → **(S.SCH 5 MHz)** → **(DW 2 MHz)** → **(SET 0)**

To enter 15.255 MHz, press **(SET 0)** → **(SCAN 1)** → **(S.SCH 5 MHz)** → **(DW 2 MHz)** → **(S.SCH 5 MHz)** → **(S.SCH 5 MHz)**

To enter 1.250 MHz (1250 kHz), press **(SET 0)** → **(SET 0)** → **(SCAN 1)** → **(DW 2 MHz)** → **(S.SCH 5 MHz)** → **(SET 0)**

To enter 0.950 MHz (950 kHz), press **(SET 0)** → **(SET 0)** → **(SET 0)** → **(SPCL 9 MHz)** → **(S.SCH 5 MHz)** → **(SET 0)**

To enter 430.000MHz, press **(ARTS 4 MHz)** → **(WX 3 MHz)** → **(WRITE MT V/M)**

3) Scanning

From the VFO mode, press the **(MON F)** key, then press the **(SCAN 7)** key. The **VX-7R** will begin scanning toward a higher frequency, and will stop when it receives a signal strong enough to break through the Squelch threshold. The **VX-7R** will then hold on that frequency according to the setting of the “RESUME” mode (Menu Item: Scan Modes #3). See page 57 for details.

If you wish to reverse the direction of the scan (i.e. toward a lower frequency, instead of a higher frequency), just rotate the **DIAL** one click in the counter-clockwise direction while the **VX-7R** is scanning. The scanning direction will be reversed. To revert to scanning toward a higher frequency once more, rotate the **DIAL** one click clockwise.

Press the **PTT** switch momentarily to cancel the scanning.

AUDIO MUTING

The Audio Mute feature is useful in situations where it would be helpful to reduce the audio level of the “Receive Only” band (*Small* character display) whenever you receive a signal on the “Main” band (*Large* character display) during Dual Receive operation.

To activate the Audio Mute feature:

1. Press the **MON F** key, then press the **SET** key to enter the Set mode.
2. Rotate the **DIAL** to select the Menu Item labeled (**Basic Operation #8: MUTE SET**).
3. Press the **MAIN** or **SUB** key to select “ON” (to enable Audio Mute feature).
4. Press the **PTT** switch to save the new setting and exit to normal operation.
5. To disable the Audio Mute feature, select “OFF” in step 3 above.

Basic Setup	:	8
MUTE SET		
		OFF

VFO	145.000	
		NFM
VFO	433.000	
		NFM
		<input checked="" type="checkbox"/> <input type="checkbox"/>

When the Audio Mute feature is activated, the “” icon will appear on the display.

BAND LINKING

For split operation on Amateur bands, the BAND Link feature may be useful.

1. Set up dual receive operation, as just described.
2. Press the **MON F** key, then press the **SET** key to enter the Set mode.
3. Rotate the **DIAL** to select the Menu Item labeled (**Misc Setup #9: BAND LINK**).
4. Press the **MAIN** or **SUB** key to set this Menu Item to ON.
5. Press the **PTT** key to save the new setting and exit to Linked/Dual receive operation.

Misc Setup	:	9
BAND LINK		
		OFF

As you rotate the **DIAL**, you will observe that both bands’ frequencies are changing together. When you are done with this operating mode, re-enter the Set mode, and set (**Misc Setup #9: BAND LINK**) to OFF.



The BAND Link feature requires that (1) “Main” band and “Sub” band be set to same band (Dual In-band receive), (2) Menu Item (Misc Setup #10: VFO MODE) must be set to “BAND.” In other words, the BAND Link feature cannot activated if “Main” band and “Sub” band are not set to the same band, or if Menu Item (Misc Setup #10: VFO MODE) is set to “ALL.”



OPERATION

TRANSMISSION

Once you have set up an appropriate frequency inside one of the three (or four) Amateur bands on which the **VX-7R** can transmit (50 MHz, 144 MHz, or 430 MHz, plus 222 MHz on the USA version), you're ready to transmit. These are the most basic steps; more advanced aspects of transmitter operation will be discussed later.

1. To transmit, press the **PTT** switch, and speak into the front panel microphone (located in the upper right-hand corner of the speaker grille) in a normal voice level. The "**STROBE**" will glow red during transmission.
2. To return to the receive mode, release the **PTT** switch.
3. During transmission, the relative power level will be indicated on the LCD. Full power (5 Watts) is indicated by eight arrows below the frequency display. The three "Low Power" levels (L1, L2, and L3) are indicated by two, four, or six arrows, respectively. Additionally, the "**L1**," "**L2**," or "**L3**" icon will appear at the bottom of the display, corresponding with the "Low Power" Level setting.



If you're just talking to friends in the immediate area, you'll get much longer battery life by switching to Low Power operation. To do this, press the  key, then press the  key so that the "L" icon appears at the bottom of the display. And don't forget: always have an antenna connected when you transmit.





Transmission is not possible on any operating bands other than the 50 MHz, 144 MHz, 222 MHz, and 430 MHz bands.

Changing the Transmitter Power Level

You can select between a total of four transmitter power levels on your **VX-7R**. The exact power output will vary somewhat, depending on the voltage supplied to the transceiver. With the standard **FNB-80LI** Battery Pack and external DC source, the power output levels available are:

	ICONS			
	NONE	L3	L2	L1
50/144/430 MHz	5.0 W	2.5 W	1.0 W	0.05 W
222 MHz FM	—	—	0.3 W	0.05 W
50 MHz AM	1.0 W (Fixed)			

To change the power level:

1. The default setting for the power output is "High;" in this configuration, the LCD shows no indication of the power output level. Pressing the  key, followed by the  key, causes the power level "**L1**," "**L2**," or "**L3**" to appear.
2. Press the  key, followed by the  key (repeatedly, if necessary) to make the "Low Power" icon disappear and restore High Power operation.



*1) The **VX-7R** is smart! You can set up Low power on one band (like UHF), while leaving VHF on High power, and the radio will remember the different settings on each band. And when you store memories, you can store High and Low power settings separately in each memory, so you don't waste battery power when using very close-in repeaters!*

TRANSMISSION

2) When you are operating on one of the Low power settings, you can press the **(MONF)** key, then press the **PTT** switch, to cause the **VX-7R** to transmit (temporarily) on High power. After one transmission, the power level will revert to the previously-selected Low power setting.

VOX OPERATION

The VOX system provides automatic transmit/receive switching based on voice input to the microphone. With the VOX system enabled, you do not need to press the **PTT** switch in order to transmit, and it is not necessary to use a VOX headset in order to utilize VOX operation.

1. Press the **(MONF)** key, then press the **(SET)** key to enter the Set mode.
2. Rotate the **DIAL** to select the Menu Item labeled (Misc Setup #7: VOX SENS).
3. Press the **(MAIN)** or **(SUB)** key to select the desired VOX Gain level (“HIGH” or “LOW”).
4. When you have made your choice, press the **PTT** key to save the new setting and return to normal operation.
5. Without pressing the **PTT** switch, speak into the microphone in a normal voice level. When you start speaking, the transmitter should be activated automatically. When you finish speaking, the transceiver should return to the receive mode (after a short delay).
6. To cancel VOX and return to **PTT** operation, just repeat the above procedures, selecting “OFF” in step 3 above.

Misc Setup	: 7
VOX SENS	
	OFF

When the VOX system is activated, the “**[V]**” icon will appear on the display.

VFO	145.000	NFM
VFO	433.000	NFM
		[V] [S]

The **VX-7R** provides for adjustment of the “Hang-Time” of the VOX system (the transmit-receive delay after the cessation of speech) via the Menu. The default delay is 1/2 second. To set a different delay time:



1. Press the **(MONF)** key, then press the **(SET)** key to enter the Set mode.
2. Rotate the **DIAL** to select the Menu Item labeled (Misc Setup #8: VOX DELAY).
3. Press the **(MAIN)** or **(SUB)** key to select the delay time among “0.5sec,” “1sec,” and “2sec.”
4. When you have made your choice, press the **PTT** key to save the new setting and return to normal operation.

Misc Setup	: 8
VOX DELAY	
	0.5sec

OPERATION

AM BROADCAST RECEPTION

The **VX-7R** includes provision for reception of AM broadcasts, either on the standard medium-wave (MW) broadcast band, or on the shortwave bands up to 16 MHz.

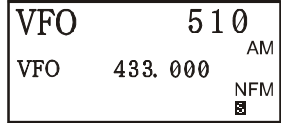

1. Set the **VX-7R** to the VFO mode on the “Main” band.
2. Press the  key (or press  → ) repetitively until you see a frequency in the frequency range desired. The MW coverage is 0.5 MHz to 1.8 MHz, while the shortwave broadcast coverage is 1.8 MHz to 16 MHz. In either case, the operating mode (displayed on the right edge of the LCD) should be shown as being “AM.”
3. Rotate the **DIAL** to tune across the broadcast band.
4. You may also use the keypad to enter frequencies directly. This method will be quicker for changing from the 49-meter broadcast band to the 31-meter band, for example.



- 1) *If the operating mode is not correct, you may need to adjust the setting of the Menu Item labeled (Basic Setup #4: RX MODE). See page 26 for details.*
- 2) *The VX-7R includes a special memory bank into which the factory has stored 89 frequencies representing popular Short-wave Broadcast stations. See page 55 for details.*

AM AIRCRAFT RECEPTION

Reception of AM signals in the aeronautical band (108-137 MHz) is similar to that described in the previous section.

1. Be sure that the **VX-7R** is set to the VFO mode on the “Main” band.
2. Press the  key (or press  → ) repetitively until you see a frequency in the aeronautical band.
3. Rotate the **DIAL** to tune across the aeronautical band.
4. You may also use the keypad to enter frequencies directly.

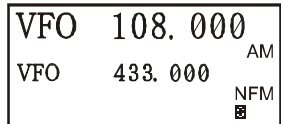





Remember that frequencies quoted by aircraft operators may be abbreviated, and that the “5” at the end of a frequency may be dropped. Since aeronautical channels are assigned in 25-kHz steps, therefore, a frequency announced as “thirty-two, forty-two” corresponds to an operating frequency of 132.425 MHz.

FM BROADCAST/TV AUDIO RECEPTION



The **VX-7R** also includes provision for reception in the FM broadcast band, utilizing a wide-bandwidth filter which provides excellent fidelity.

To Activate FM Broadcast Reception

1. Be sure that the **VX-7R** is set to the VFO mode on the “Main” band.
2. Press the  key (or press  → ) repetitively until a frequency in the FM broadcast band appears on the display. The total frequency range included in the “FM” band is 59-108 MHz.
3. Rotate the **DIAL** to select the desired station. The default synthesizer steps for the W-FM mode are 100 kHz/step.

VFO	59. 000	WFM
VFO	433. 000	NFM
		

To Activate VHF or UHF TV Audio Reception

1. Be sure that the **VX-7R** is set to the VFO mode on the “Main” band.
2. Press the  key (or press  → ) repetitively until a frequency in the VHF or UHF TV bands appears on the LCD.
3. Rotate the **DIAL** to select the desired station.

VFO	174. 000	WFM
VFO	433. 000	NFM
		



Remember that the Wide-FM Squelch setting may be made independently from the Narrow-FM setting, using the Menu Item labeled (Basic Setup #2: SQL WFM). See page 84.

OPERATION

WEATHER BROADCAST RECEPTION

The **VX-7R** includes a unique feature which allows reception of weather broadcasts in the 160-MHz frequency range. Ten standard Weather Broadcast channels are pre-loaded into a special memory bank.

To listen to a Weather Broadcast Channel or VHF Marine Channel:

1. Press the **(MON F)** key, then press the **(WX 3err)** key to recall the Weather Broadcast channels.
2. Turn the **DIAL** knob to select the desired Weather Broadcast channel.
3. If you wish to check the other channels for activity by scanning, just press the **PTT** switch.
4. To exit to normal operation, again the **(MON F)** key, then press the **(WX 3err)** key. Operation will return to the VFO or Memory channel you were operating on before you began Weather Broadcast operation.

WX	162.550	NFM
1		
VFO	433.000	NFM
		<input checked="" type="checkbox"/>



In the event of extreme weather disturbances, such as storms and hurricanes, the NOAA (National Oceanic and Atmospheric Administration) sends a weather alert accompanied by a 1050 Hz tone and subsequent weather report on one of the NOAA weather channels. You may disable the Weather Alert tone via Menu Item (Misc Setup #20 WX ALERT), if desired.









downloaded by
www.radioamatore.info

KEYBOARD LOCKING

In order to prevent accidental frequency change or inadvertent transmission, various aspects of the **VX-7R**'s keys and switches may be locked out. The possible lockout combinations are:

- KEY:** Just the front panel keys are locked out
- DIAL:** Just the top panel **DIAL** is locked out
- KEY+DIAL:** Both the **DIAL** and Keys are locked out
- PTT:** The **PTT** switch is locked (TX not possible)
- KEY+PTT:** Both the keys and **PTT** switch are locked out
- DIAL + PTT:** Both the **DIAL** and **PTT** switch are locked out
- ALL:** All of the above are locked out

To lock out some or all of the keys:

1. Press the  key, then press the  key to enter the Set mode.
 2. Rotate the **DIAL** to select the Menu Item labeled (**Basic Setup #10: LOCK MODE**).
- | | |
|-------------|-----|
| Basic Setup | :10 |
| LOCK MODE | |
| | KEY |
3. Press the  or  key to choose between one of the locking schemes as outlined above.
 4. When you have made your selection, press the **PTT** switch to save the new setting and resume normal operation.
 5. To activate the locking feature, *press and hold in* the  key for 2 seconds. The “” icon will appear on the LCD. To cancel locking, again *press and hold* the  key for 2 seconds.
- | | | |
|---|----------|---|
| VFO | 145. 000 | NFM |
| VFO | 433. 000 | NFM |
|  | |  |



Even when “ALL” keys have been locked out, one key actually is not locked out: the  key remains available so you can unlock your keypad when you want to!

downloaded by
www.radioamatore.info

OPERATION

KEYPAD/LCD ILLUMINATION

Your **VX-7R** includes a reddish illumination lamp which aids in nighttime operation. The red illumination yields clear viewing of the display in a dark environment, with minimal degradation of your night vision. Three options for activating the lamp are provided:

- KEY Mode:** Illuminates the Keypad/LCD for 5 seconds when any key pressed.
- CONTINUE Mode:** Illuminates the Keypad/LCD continuously.
- OFF Mode:** Disables the Keypad/LCD lamp.

Here is the procedure for setting up the Lamp mode:

1. Press the **(MONF)** key, then press the **(SET 0)** key to enter the Set mode.
2. Rotate the **DIAL** to select the Menu Item labeled (**Display Setup #5: LAMP MODE**).
3. Press the **(MAIN)** or **(SUB)** key to select one of the three modes described above.
4. When you have made your choice, press the **PTT** key to save the new setting and return to normal operation.

Display Setup : 5 LAMP MODE KEY

DISABLING THE KEYPAD BEEPER

If the keypad's Beeper creates an inconvenience (particularly when operating in a quiet room), it may easily be disabled.

1. Press **(MONF)** key, then press the **(SET 0)** key to enter the Set mode.
2. Rotate the **DIAL** to select the Menu Item labeled (**Basic Setup #9: KEY BEEP**).
3. Press the **(MAIN)** or **(SUB)** key to change the setting from **ON** to **OFF**.
4. When you have made your selection, press the **PTT** key to save the new setting and exit to normal operation.
5. If you wish to re-enable the Beeper, just repeat the above procedure, pressing the **(MAIN)** or **(SUB)** key to select **ON** in step "3" above.

Basic Setup : 9 KEY BEEP ON

downloaded by
www.radioamatore.info

ADVANCED OPERATION

Now that you're mastered the basics of **VX-7R** operation, let's learn more about some of the really neat features.

SETTING THE FREQUENCY DISPLAY IMAGE SIZE

VFO Mode

When operating in the VFO mode during the “Mono” band operation, pressing the **(MON F)** key, then pressing the **(MAIN)** or **(SUB)** key, causes the LCD to “toggle” between display of *double-size* characters and *large* characters. However, this feature does not work during Dual Receive operation, as two frequencies are displayed in that instance.

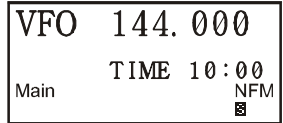

Memory Mode

When operating in the Memory mode (see page 45), pressing the **(MON F)** key, followed by the **(MAIN)** or **(SUB)** key, causes the LCD to “toggle” between display of the current memory's frequency (in *double-size* characters) and the current memory's frequency (in *large* characters) with its alpha-numeric Tag (small characters). This feature likewise does not activate during Dual Receive operation.

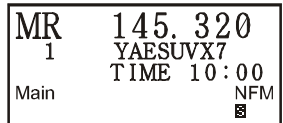
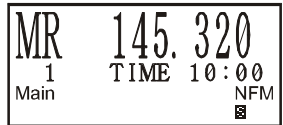

CHANGING THE CHANNEL STEPS

The **VX-7R**'s synthesizer provides the option of utilizing channel steps of 5/9/10/12.5/15/20/25/50/100 kHz per step, any number of which may be important to your operating requirements. The **VX-7R** is set up at the factory with different default steps on each operating band which probably are satisfactory for most operation. However, if you need to change the channel step increments, the procedure to do so is very easy.

1. Press the **(MON F)** key, then press the **(SET)** key to enter the Set mode.
2. Rotate the **DIAL** to select the Menu Item labeled (**Basic Setup #3: VFO STEP**).
3. Press the **(MAIN)** or **(SUB)** key to select the new channel step size.
4. Press the **PTT** key to save the new setting and exit to normal operation.

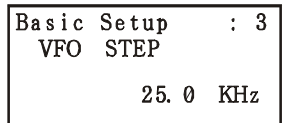

9 kHz step is available on the BC band only.

ADVANCED OPERATION

CHANGING THE OPERATING MODE

The **VX-7R** provides for automatic mode changing when the radio is tuned to different operating frequencies. However, should an unusual operating situation arise in which you need to change between the available operating modes (FM-Narrow, FM-Wide, and AM), here is the procedure for doing so:

1. Press the **MONF** key, then press the **SET** key to enter the Set mode.

2. Rotate the **DIAL** to select the Menu Item labeled (**Basic Setup #4: RX MODE**).

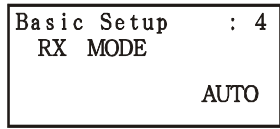

3. Press the **MAIN** or **SUB** key to select the new channel step size. The available selections are:

AUTO: Automatic mode setting per default values for the selected frequency range..

N-FM: Narrow-bandwidth FM (used for voice communication)

W-FM: Wide-bandwidth FM (used for high-fidelity broadcasting)

AM: Amplitude Modulation

4. Press the **PTT** key to save the new setting and exit to normal operation.



Unless you have a compelling reason to do so, leave the Automatic Mode Selection feature on so as to save time and trouble when changing bands. If you make a mode change for a particular channel or station, you can always store that one channel into memory, as the mode setting will be memorized along with the frequency information.

downloaded by
www.radioamatore.info

REPEATER OPERATION

Repeater stations, usually located on mountaintops or other high locations, provide a dramatic extension of the communication range for low-powered hand-held or mobile transceivers. The **VX-7R** includes a number of features which make repeater operation simple and enjoyable.

Repeater Shifts

Your **VX-7R** has been configured, at the factory, for the repeater shifts customary in your country. For the 50 MHz band, this usually will be 1 MHz, while the 144 MHz shift will be 600 kHz; on 70 cm, the shift may be 1.6 MHz, 7.6 MHz, or 5 MHz (USA version).

Depending on the part of the band in which you are operating, the repeater shift may be either downward (-) or upward (+), and one of these icons will appear at the bottom of the LCD when repeater shifts have been enabled.

Automatic Repeater Shift (ARS)

The **VX-7R** provides a convenient Automatic Repeater Shift feature, which causes the appropriate repeater shift to be automatically applied whenever you tune into the designated repeater sub-bands in your country. These sub-bands are shown below.

If the ARS feature does not appear to be working, you may have accidentally disabled it.

To re-enable ARS:

1. Press the **(MON F)** key, then press the **(SET 0)** key to enter the Set mode.
2. Rotate the **DIAL** to select the Menu Item labeled (**Basic Setup #5: ARS**).
3. Press the **(MAIN)** or **(SUB)** key to select "**ON**" (to enable Automatic Repeater Shift).
4. Press the **PTT** key to save the new setting and exit to normal operation.

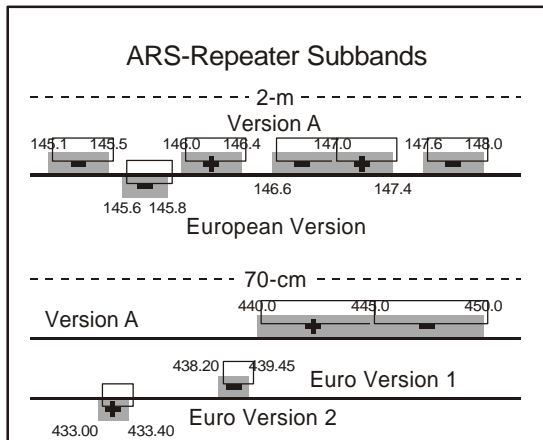

ADVANCED OPERATION

REPEATER OPERATION

Manual Repeater Shift Activation

If the ARS feature has been disabled, or if you need to set a repeater shift direction other than that established by the ARS, you may set the direction of the repeater shift manually.

To do this:

1. Press the **(MONF)** key, then press the **(SET 0)** key to enter the Set mode.
2. Rotate the **DIAL** to select the Menu Item labeled (**Basic Setup #7: RPT SHIFT**).
3. Press the **(MAIN)** or **(SUB)** key to select the desired shift among “-RPT,” “+RPT,” and “SIMP.”
4. Press the **PTT** key to save the new setting and exit to normal operation.

Basic Setup	:	7
RPT SHIFT		
		SIMP

Changing the Default Repeater Shifts

If you travel to a different region, you may need to change the default repeater shift so as to ensure compatibility with local operating requirements.

To do this, follow the procedure below:

1. Press the **(MONF)** key, then press the **(SET 0)** key to enter the Set mode.
2. Rotate the **DIAL** to select the Menu Item labeled (**Basic Setup #6: SHIFT**).
3. Press the **(MAIN)** or **(SUB)** key to select the new repeater shift magnitude.
4. Press the **PTT** key to save the new setting and exit to normal operation.

Basic Setup	:	6
SHIFT		
		5.00 MHz





If you just have one “odd” split that you need to program, don’t change the “default” repeated shifts using this Menu Item! Enter the transmit and receive frequencies separately, as shown on page 46.

REPEATER OPERATION

Checking the Repeater Uplink (Input) Frequency

It often is helpful to be able to check the uplink (input) frequency of a repeater, to see if the calling station is within direct (“Simplex”) range.

To do this, just press the  key. You’ll notice that the display has shifted to the repeater uplink frequency. Press the  key again to cause operation to revert to normal monitoring of the repeater downlink (output) frequency.



The configuration of this key may be set either to “RV” (for checking the input frequency of a repeater, or “HM” (for instant switching to the “Home” channel for the band you are operating on). To change the configuration of this key, use Menu Item (Misc. Setup #2 HOM/REV). See page 49.

downloaded by
www.radioamatore.info





ADVANCED OPERATION

CTCSS OPERATION

Many repeater systems require that a very-low-frequency audio tone be superimposed on your FM carrier in order to activate the repeater. This helps prevent false activation of the repeater by radar or spurious signals from other transmitters. This tone system, called “CTCSS” (Continuous Tone Coded Squelch System), is included in your **VX-7R**, and is very easy to activate.









CTCSS setup involves two actions: setting the Tone Frequency and then setting of the Tone Mode. These actions are set up by using the  key, or Menu Items (TSQ/DCS/DTMF #1: SQL TYPE) and (TSQ/DCS/DTMF #2: TONE SET).

1. Press the  key, then press the  key. This provides a “Short-cut” to Menu Item (TSQ/DCS/DTMF #1: SQL TYPE).
2. Press the  or  key so that “TONE” appears on the display; this activates the CTCSS Encoder, which allows repeater access.

TSQ/DCS/DTMF	: 1
SQL TYPE	
	OFF



You may notice an additional “DCS” icon appearing while you press the  or  key in this step. We’ll discuss the Digital Code Squelch system shortly.

3. Pressing the  key in step “2” above will occasionally cause “SQL” to appear adjacent to the “TONE.” When “TONE SQL” appears, this means that the Tone SQuelch system is active, which mutes your **VX-7R**’s receiver until it receives a call from another radio sending out a matching CTCSS tone. This can help keep your radio quiet until a specific call is received, which may be helpful while operating in congested areas.
4. When you have made your selection of the CTCSS tone mode, rotate the **DIAL** one click clockwise to select Menu Item labeled (TSQ/DCS/DTMF #2: TONE SET). This Menu selection allows setting of the CTCSS tone *frequency* to be used.
5. Press the  key to enable the adjustment of the CTCSS frequency.
6. Press the  or  key until the display indicates the Tone Frequency you need to be using (ask the repeater owner/operator if you don’t know the tone frequency).
7. When you have made your selection, press the  key, then press the **PTT** switch to save the new settings and exit to normal operation.

TSQ/DCS/DTMF	: 2
TONE SET	
	100.0 Hz



Your repeater may or may not re-transmit a CTCSS tone - some systems just use CTCSS to control access to the repeater, but don’t pass it along when transmitting. If the S-Meter deflects, but the **VX-7R is not passing audio, repeat steps “1” through “3” above, but rotate the **DIAL** so that “SQL” disappears - this will allow you to hear all traffic on the channel being received.**

DCS OPERATION

Another form of tone access control is Digital Code Squelch, or DCS. It is a newer, more advanced tone system which generally provides more immunity from false paging than does CTCSS. The DCS Encoder/Decoder is built into your **VX-7R**, and operation is very similar to that just described for CTCSS. Your repeater system may be configured for DCS; if not, it is frequently quite useful in Simplex operation if your friend(s) use transceivers equipped with this advanced feature.



Just as in CTCSS operation, DCS requires that you set the Tone Mode to DCS and that you select a tone code.

1. Press the **[MONI]** key, then press the **[TONE]** key. This provides a “Short-cut” to Menu Item (TSQ/DCS/DTMF # 1: SQL TYPE).
2. Press the **[MAIN]** or **[SUB]** key until “DCS” appears on the display; this activates the DCS Encoder/Decoder.
3. Now rotate the **DIAL** to select Menu Item (TSQ/DCS/DTMF # 3: DCS SET).
4. Press the **[BAND]** key to enable the adjustment of the DCS code.
5. Press the **[MAIN]** or **[SUB]** key to select the desired DCS Code (a three-digit number). Ask the repeater owner/operator if you don’t know DCS Code; if you are working simplex, just set up the DCS Code to be the same as that used by your friend(s).
6. When you have made your selection, press the **[BAND]** key, then press the **PTT** switch to save the new settings and exit to normal operation.

TSQ/DCS/DTMF	: 1
SQL TYPE	
	OFF

TSQ/DCS/DTMF	: 3
DCS SET	
	023



Remember that the DCS is an Encode/Decode system, so your receiver will remain muted until a matching DCS code is received on an incoming transmission. Switch the DCS off when you’re just tuning around the band!

CTCSS TONE FREQUENCY (Hz)					
67.0	69.3	71.9	74.4	77.0	79.7
82.5	85.4	88.5	91.5	94.8	97.4
100.0	103.5	107.2	110.9	114.8	118.8
123.0	127.3	131.8	136.5	141.3	146.2
151.4	156.7	159.8	162.2	165.5	167.9
171.3	173.8	177.3	179.9	183.5	186.2
189.9	192.8	196.6	199.5	203.5	206.5
210.7	218.1	225.7	229.1	233.6	241.8
250.3	254.1	–	–	–	–

DCS CODE									
023	025	026	031	032	036	043	047	051	053
054	065	071	072	073	074	114	115	116	122
125	131	132	134	143	145	152	155	156	162
165	172	174	205	212	223	225	226	243	244
245	246	251	252	255	261	263	265	266	271
274	306	311	315	325	331	332	343	346	351
356	364	365	371	411	412	413	423	431	432
445	446	452	454	455	462	464	465	466	503
506	516	523	526	532	546	565	606	612	624
627	631	632	654	662	664	703	712	723	731
732	734	743	754	–	–	–	–	–	–



ADVANCED OPERATION

TONE SEARCH SCANNING



In operating situations where you don't know the CTCSS or DCS tone being used by another station or stations, you can command the radio to listen to the incoming signal and scan in search of the tone being used. Two things must be remembered in this regard:

- You must be sure that your repeater uses the same tone type (CTCSS vs. DCS).
- Some repeaters do not pass the CTCSS tone; you may have to listen to the station(s) transmitting on the repeater uplink (input) frequency in order to allow Tone Search Scanning to work.

To scan for the tone in use:

1. Set the radio up for either CTCSS or DCS Decoder operation (see the previous discussion). In the case of CTCSS, "TSQ" will appear on the display; in the case of DCS, "DCS" will appear on the display.
2. Press the  key, then press the  key to enter the Set mode.
3. Rotate the **DIAL** to select the Menu Item labeled (TSQ/DCS/DTMF #2: TONE SET) when TONE SQL is selected, or Menu Item labeled (TSQ/DCS/DTMF #3: DCS SET) during DCS operation.

TSQ/DCS/DTMF	: 2
TONE SET	
	100.0 Hz
4. Press the  key to enable adjustment of the selected Menu Item.

TSQ/DCS/DTMF	: 3
DCS SET	
	023
5. Press the  key, then press the  key to start scanning for the incoming CTCSS or DCS tone/code.
6. When the radio detects the correct tone or code, it will halt on that tone/code, and audio will be allowed to pass. Press the  key to lock in that tone/code, then press **PTT** to exit to normal operation.



*If the Tone Scan feature does not detect a tone or code, it will continue to scan indefinitely. When this happens, it may be that the other station is not sending any tone. You can press the **PTT** switch to halt the scan at any time.*

You also can press the **MONI** key during Tone Scanning to listen to the (muted) signal from the other station. When you release the **MONI** key, Tone Scanning will resume after about a second.

Tone Scanning works either in the VFO or Memory modes.

CTCSS/DCS BELL OPERATION

During CTCSS Decode or DCS operation, you may set up the **VX-7R** such that a ringing “bell” sound alerts you to the fact that a call is coming in. Here is the procedure for activating the CTCSS/DCS Bell:

1. Set the transceiver up for CTCSS Decode (“Tone Squelch”) or DCS operation, as described previously.
2. Adjust the operating frequency to the desired channel.
3. Press the **[MON F]** key, then press the **[TONE 8MHz]** key to enter the Set mode.
4. Rotate the **DIAL** to select the Menu Item labeled (TSQ/DCS/DTMF #5: BELL).
5. Press the **[MAIN]** or **[SUB]** key to set the desired number of rings of the Bell. The available choices are **1, 3, 5, or 8** rings, **CONTINUE** (continuous ringing), or **OFF**.
6. Press the **PTT** key momentarily to save the new setting and exit to normal operation.

TSQ/DCS/DTMF	:	5
BELL		
		OFF

When you are called by a station whose transceiver is sending a CTCSS tone or DCS code which matches that set into your Decoder, the Bell will ring in accordance to this programming.

SPLIT TONE OPERATION

The **VX-7R** can be operated in a Split Tone configuration via the Set mode.

1. Press the **[MON F]** key, then press the **[TONE 8MHz]** key to enter the Set mode.
2. Rotate the **DIAL** to select the Menu Item labeled (TSQ/DCS/DTMF #6: SPLIT TONE).
3. Press the **[MAIN]** or **[SUB]** key to select **ON** (to enable the Split Tone feature).
4. Press the **PTT** key momentarily to save the new setting and exit to normal operation.

TSQ/DCS/DTMF	:	6
SPLIT TONE		
		OFF

When the Split Tone feature is activated, you can see the following additional parameters after the “DCS” parameter while selecting the Menu Item (TSQ/DCS/DTMF #1: SQL TYPE):

D CODE: DCS Encode only (“**D**” icon will appear while operating)

STONE DC: Encodes a CTCSS Tone and Decodes a DCS code
(the “**T ■ D**” icon will appear during operation)

DC TONE: Encodes a DCS code and Decodes a CTCSS Tone
(the “**D ■ T**” icon will appear during operation)

Select the desired operating mode from the selections shown above.

ADVANCED OPERATION

TONE CALLING (1750 Hz)

If the repeaters in your country require a 1750-Hz burst tone for access (typically in Europe), you can set the **MONI** key to serve as a “Tone Call” switch instead. To change the configuration of this switch, we again use the Menu to help us.

1. Press the **MONI** key, then press the **SET** key to enter the Set mode.
2. Rotate the **DIAL** to select the Menu Item labeled (**Misc Setup #3 MONI/T-CAL**).
3. Press the **MAIN** or **SUB** key to select “T-CALL” on the display.
4. Press the **PTT** key to save the new setting and exit to normal operation.
5. To access a repeater, press and hold in the **MONI** key for the amount of time specified by the repeater owner/operator. The transmitter will automatically be activated, and a 1750-Hz audio tone will be superimposed on the carrier. Once access to the repeater has been gained, you may release the **MONI** key, and use the **PTT** key for activating the transmitter.

Misc Setup	: 3
MONI/T-CAL	
	MONI

downloaded by
www.radioamatore.info

ARTS (AUTOMATIC RANGE TRANSPONDER SYSTEM)

The ARTS feature uses DCS signaling to inform both parties when you and another ARTS-equipped station are within communications range. This may be particularly useful during Search-and Rescue situations, where it is important to stay in contact with other members of your group.

Both stations must set up their DCS codes to the same code number, then activate their ARTS feature using the command appropriate for their radio. Alert ringers may be activated, if desired.

Whenever you push the **PTT**, or every 25 (or 15) seconds after ARTS is activated, your radio will transmit a signal which includes a (subaudible) DCS signal for about 1 second. If the other radio is in range, the beeper will sound (if enabled) and the display will show “**IN RANGE**” as opposed to the out of range display “**OUT RANGE**” in which ARTS operation begins.

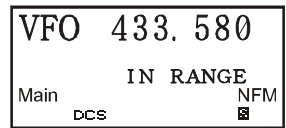

Whether you talk or not, the polling every 15 or 25 seconds will continue until you de-activate ARTS. Every 10 minutes, moreover, you can have your radio transmit your callsign via CW, so as to comply with identification requirements. When ARTS is de-activated, DCS will also be deactivated (if you were not using it previously in non-ARTS operation).

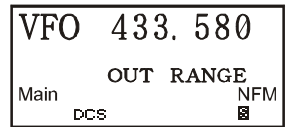



If you move out of range for more than one minute (four pollings), your radio will sense that no signal has been received, three beeps will sound, and the display will revert to “**OUT RANGE.**” If you move back into range, your radio will again beep, and the display will change back to the “**IN RANGE**” indication.

During ARTS operation, your operating frequency will continue to be displayed, but no changes may be made to it or other settings; you must terminate ARTS in order to resume normal operation. This is a safety feature designed to prevent accidental loss of contact due to channel change, etc.

Here is how to activate ARTS:

Basic ARTS Setup and Operation

1. Set your radio and the other radio(s) to the same DCS code number, per the discussion on page 31.
2. Press the  key, then press the  key. You will observe the “**OUT RANGE**” display on the LCD below the operating frequency. ARTS operation has now commenced.
3. Every 25 seconds, your radio will transmit a “polling” call to the other station. When that station responds with its own ARTS polling signal, the display will change to “**IN RANGE**” to confirm that the other station’s polling code was received in response to yours.

ADVANCED OPERATION

ARTS (AUTOMATIC RANGE TRANSPONDER SYSTEM)

4. Press the **MONF** key, then press the **ARTS** key to exit ARTS operation and resume normal functioning of the transceiver.



ARTS won't work if you have used the Lock feature to disable the PTT!

ARTS Polling Time Options

The ARTS feature may be programmed to poll every 25 seconds (default value) or 15 seconds. The default value provides maximum battery conservation, because the polling signal is sent out less frequently. To change the polling interval:

1. Press the **MONF** key, then press the **SET** key to enter the Set mode.
2. Rotate the **DIAL** to select the Menu Item labeled (**ARTS #2: ARTS INTERVAL**).
3. Press the **MAIN** or **SUB** key to select the desired polling interval (15 or 25 seconds).
4. When you have made your selection, press the **PTT** key to save the new setting and exit to normal operation.

ARTS	:	2
ARTS INTERVAL		
		25 sec

ARTS Alert Beep Options

The ARTS feature allows two kinds of alert beeps (with the additional option of turning them off), so as to alert you to the current status of ARTS operation. Depending on your location and the potential annoyance associated with frequent beeps, you may choose the Beep mode which best suits your needs. The choices are:

IN RANGE: The beeps are issued only when the radio first confirms that you are within range, but does not re-confirm with beeps thereafter.

ALWAYS: Every time a polling transmission is received from the other station, the alert beeps will be heard.

OFF: No alert beeps will be heard; you must look at the display to confirm current ARTS status.

To set the ARTS Beep mode, use the following procedure:

1. Press the **MONF** key, then press the **SET** key to enter the Set mode.
2. Rotate the **DIAL** to select the Menu Item labeled (**ARTS #1: ARTS BEEP**).
3. Press the **MAIN** or **SUB** key to select the desired ARTS Beep mode (see above).
4. When you have made your selection, press the **PTT** key to save the new setting and exit to normal operation.

ARTS	:	1
ARTS BEEP		
		IN RANGE

ARTS (AUTOMATIC RANGE TRANSPONDER SYSTEM)

CW Identifier Setup

The ARTS feature includes a CW identifier, as discussed previously. Every ten minutes during ARTS operation, the radio can be instructed to send “**DE (your callsign) K**” if this feature is enabled. The callsign field may contain up to 16 characters.

Here’s how to program the CW Identifier:

1. Press the **(MON F)** key, then press the **(SET)** key to enter the Set mode.
2. Rotate the **DIAL** to select the Menu Item labeled **(ARTS #3: CW ID)**.
3. Press the **(BND DN BAND)** key to enable changing of this Menu item. The “_” indicator will blink on the LCD.
4. Press the **(MAIN)** or **(SUB)** key to set the CW ID function to **ON**.
5. Rotate the **DIAL** one click clockwise to begin entry of the letters and numbers in your callsign.
6. Press the **(MON F)** key or keyboard to set the first letter or number in your callsign.
Example 1: Press the **(MON F)** key to select any of the 7 available characters (including the “slant bar” for portable stations); or
Example 2: Press the **(DW 2/200)** key repeatedly to toggle among the seven available characters associated with that key: **A → B → C → a → b → c → 2**
7. When the correct character has been selected, rotate the **DIAL** one click clockwise to move on to the next character.
8. Repeat steps 6 and 7 as many times as necessary to complete your callsign. Note that the “slant bar” (–••–•) is among the available characters, should you be a “portable” station.
9. Press the **(FMG 1/10)** key to delete all data after the cursor that may have been previously stored erroneously.
10. When you have entered your entire callsign, press the **(BND DN BAND)** key to confirm the callsign, then press the **PTT** key to save the settings and exit to normal operation.

ARTS	: 3
CW ID	
OFF	



*You may check your work by monitoring the entered callsign. To do this, repeat steps 1 - 3 above, then press the **(MON F)** key.*

ADVANCED OPERATION

DTMF OPERATION

The **VX-7R**'s 16-button keypad allows easy DTMF dialing for Autopatch, repeater control, or Internet-link access purposes. Besides numerical digits [0] through [9], the keypad includes the [*] and [#] digits, plus the [A], [B], [C], and [D] tones often used for repeater control.

Manual DTMF Tone Generation

You can generate DTMF tones during transmission manually.

1. Press the **PTT** switch to begin transmission.
2. While transmitting, press the desired numbers on the keypad.
3. When you have sent all the digits desired, release the **PTT** key.

DTMF Autodialer

Nine DTMF Autodial memories are provided, allowing you to store telephone numbers for autopatch use. You can also store short autopatch or Internet-link access code streams so as to avoid having to send them manually.

Here is the DTMF Autodial storage procedure:

1. Press the **MONF** key, then press the **SET** key to enter the Set mode.
2. Rotate the **DIAL** knob to select the Menu Item labeled (TSQ/DCS/DTMF #8: DTMF SET).
3. Press the **BAND DN** key to enable adjustment of this Menu Item.
4. Press the **MAIN** or **SUB** key to select the DTMF Memory register into which you wish to store this DTMF string.
5. Rotate the **DIAL** knob one click to begin DTMF Memory entry into the selected register.
6. Key in the DTMF digits you wish to store into this register. If needed, you may press the **MAIN** key to store a "Pause" (rotate the **DIAL** one click clockwise to continue) or press the **MAIN** key again to delete the previously-stored data after the cursor.
7. If you make a mistake, rotate the **DIAL** knob counterclockwise to back-space the cursor, re-enter the correct number.
8. Press the **PTT** switch to save the setting. To store other numbers, repeat this process, using a different DTMF memory register.

TSQ/DCS/DTMF	: 8
DTMF SET	
CH1	

downloaded by
www.radioamatore.info

DTMF OPERATION

To send the telephone number:

1. Press the **MONI** key, then press the **SET** key to enter the Set mode.
2. Rotate the **DIAL** to select the Menu Item labeled (TSQ/DCS/DTMF #7: DTMF DIALER).
3. Press the **MAIN** or **SUB** key to set the DTMF Autodialer function to the “ON” position.
4. Press the **PTT** switch to exit to normal operation and activate the DTMF Autodialer function (the “☎” icon will appear).
5. In the Autodialer function mode, first press the **PTT** key, then press the numerical key (**SCAN** **7** through **SPCL** **☎**) corresponding to the DTMF memory string you wish to send. Once the string begins, you may release the **PTT** key, as the transmitter will be held “on the air” until the DTMF string is completed.

TSQ/DCS/DTMF	:	7
DTMF DIALER		
		OFF

VFO	145.000	NFM
VFO	433.000	NFM
		☎ ☎

EMERGENCY CHANNEL OPERATION

The **VX-7R** includes an “Emergency” feature which may be useful if you have someone monitoring on the same frequency as your transceiver’s **UHF** “Home” channel. See page 47 for details on setting the Home channel.

The “Emergency” feature is activated by pressing the **EMG** key for 1/2 seconds.

When this is done, (A) the radio is placed on the UHF amateur band Home channel, (B) it emits a loud “Alarm” sound (the volume is controlled by the **VOLUME** knob), (C) it flashes the **STROBE** in sequential colors, (D) if you press the **PTT** key, you will disable the Emergency feature temporarily; you can then transmit on the UHF Home channel, and (E) two seconds after the **PTT** release, the Emergency feature will resume.

To disable the “Emergency” feature, press the **EMG** key for 1/2 seconds or turn the radio Off by pressing and holding in the **PWR** switch for 2 seconds.

Use this feature if you are out for a walk and want a quick way of alerting a family member as to a dangerous situation. The alarm sound may discourage an attacker and allow you to escape.



1) Be sure to arrange with a friend or family member to be monitoring on the same frequency, as there will be no identification sent via the Emergency alarm sound. And do not transmit the alarm tone except in a true emergency!

*2) The **STROBE** may be changed to another function via Menu Item (Misc Setup #5: EMG SET); see page 94.*

ADVANCED OPERATION

ATT (FRONT END ATTENUATOR)

The attenuator will reduce all signals (and noise) by 20 dB, and it may be used to make reception more pleasant under extremely noisy conditions.

1. Press the **MONF** key, then press the **SET** key to enter the Set mode.
2. Rotate the **DIAL** to select the Menu Item labeled (**Misc Setup #18: ATT**).

3. Press the **MAIN** or **SUB** key to change the setting from **OFF** to **ON**.

Misc Setup	: 18
ATT	
	OFF

4. When you have made your selection, press the **PTT** key to save the new setting and exit to normal operation.
5. If you wish to disable the attenuator, just repeat the above procedure, pressing the **MAIN** or **SUB** key to select **OFF** in step “3” above.

VFO	145.000	NFM
VFO	433.000	NFM
		ATT



*When the attenuator is activated, the “**ATT**” icon will appear on the display.*

RECEIVE BATTERY SAVER SETUP

An important feature of the **VX-7R** is its Receive Battery Saver, which “puts the radio to sleep” for a time interval, periodically “waking it up” to check for activity. If somebody is talking on the channel, the **VX-7R** will remain in the “active” mode, then resume its “sleep” cycles. This feature significantly reduces quiescent battery drain, and you may change the amount of “sleep” time between activity checks using the Menu System:

1. Press the **MONF** key, then press the **SET** key to enter the Set mode.
2. Rotate the **DIAL** to select the Menu Item labeled (**Save Modes #2: RX SAVE**).

3. Press the **MAIN** or **SUB** key to select the desired “sleep” duration. The selections available are 200 ms, 300 ms, 500 ms, 1 second, and 2 seconds, or **OFF**. The default value is 200 ms.

Save Modes	: 2
RX SAVE	
	200ms(1 : 1)

4. When you have made your selection, press the **PTT** key to save the new setting and exit to normal operation.



*When you are operating on Packet, switch the Receive Battery Saver **OFF**, as the sleep cycle may “collide” with the beginning of an incoming Packet transmission, causing your **TNC** not to receive the full data burst.*

downloaded by
www.radioamatore.info

TX BATTERY SAVER

The **VX-7R** also includes a useful Transmit Battery Saver, which will automatically lower the power output level when the last signal received was very strong. For example, when you are in the immediate vicinity of a repeater station, there generally is no reason to use the full 5 Watts of power output in order to achieve full-quieting access to the repeater. With the Transmit Battery Saver, the automatic selection of Low Power operation conserves battery drain significantly.

To activate the Transmit Battery Saver:

1. Press the **MONI** key, then press the **SET** key to enter the Set mode.
2. Rotate the **DIAL** to select the Menu Item labeled (**Save Modes #3: TX SAVE**).
3. Press the **MAIN** or **SUB** key to set this Menu Item to “**ON**” (thus activating the Transmit Battery Saver).
4. When you have completed your selection, press the **PTT** key to save the new setting and exit to normal operation.

Save Modes	:	3
TX SAVE		
		OFF

DISABLING THE “STROBE”

Further battery conservation may be accomplished by disabling the “**STROBE**” while receiving a signal (when the “**STROBE**” functions as a “**BUSY**” LED). Use the following procedure:

1. Press the **MONI** key, then press the **SET** key to enter the Set mode.
2. Rotate the **DIAL** to select the Menu Item labeled (**Display Setup #1: BUSY LED**).
3. Press the **MAIN** or **SUB** key to set this Menu Item to “**OFF**” (thus disabling the BUSY lamp).
4. Press the **PTT** key to save the new setting and exit to normal operation.

Display Setup : 1
BUSY LED
ON

ADVANCED OPERATION

AUTOMATIC POWER-OFF (APO) FEATURE



The APO feature helps conserve battery life by automatically turning the radio off after a user-defined period of time within which there has been no dial or key activity.

The available selections for the time before power-off are 0.5/1/3/5/8 hours, as well as APO Off. The default condition for the APO is OFF, and here is the procedure for activating it:

1. Press the **(MONF)** key, then press the **(SET 0)** key to enter the Set mode.
2. Rotate the **DIAL** to select the Menu Item labeled (**Save Modes #1: APO**).
3. Press the **(MAIN)** or **(SUB)** key to select the desired time period after which the radio will automatically shut down.
4. Once you have made your selection, press the **PTT** key to save the new setting and exit to normal operation.

Save Modes	:	1
APO		
		OFF

When the APO is activated, the “” icon will appear at the center bottom on the LCD. If there is no action by you within the time interval programmed, the microprocessor will shut down the radio automatically.

VFO	145.000	NFM
VFO	433.000	NFM
		

Just press and hold in the **(PWR)** switch for 2 seconds to turn the transceiver back on after an APO shutdown, as usual.

TRANSMITTER TIME-OUT TIMER (TOT)

The TOT feature provides a safety switch which limits transmission to a pre-programmed value. This will promote battery conservation by not allowing you to make excessively-long transmissions, and in the event of a stuck **PTT** switch (perhaps if the radio or a Speaker/Mic is wedged between car seats) it can prevent interference to other users as well as battery depletion. As configured at the factory the TOT feature is set to OFF, and here is the procedure for activating it:

1. Press the **(MONF)** key, then press the **(SET 0)** key to enter the Set mode.
2. Rotate the **DIAL** to select the Menu Item labeled (**Save Modes #4: TOT**).
3. Press the **(MAIN)** or **(SUB)** key to set the Time-Out Timer to the desired “Maximum TX” time (1 minute, 2.5 minutes, 5 minutes, or 10 minutes).
4. Once you’re made the selection you wish to use, press the **PTT** key to save the new setting and exit to normal operation.

Save Modes	:	4
TOT		
		OFF



Since brief transmissions are the mark of a good operator, try setting up your radio’s TOT feature for a maximum transmission time of 1 minute. This will significantly improve battery life, too!

BUSY CHANNEL LOCK-OUT (BCLO)

The BCLO feature prevents the radio's transmitter from being activated if a signal strong enough to break through the "noise" squelch is present. On a frequency where stations using different CTCSS or DCS codes may be active, BCLO prevents you from disrupting their communications accidentally (because your radio may be muted by its own Tone Decoder). The default setting for the BCLO is OFF, and here is how to change that setting:

1. Press the **(MON F)** key, then press the **(SET 0)** key to enter the Set mode.
2. Rotate the **DIAL** to select the Menu Item labeled (**Misc Setup #1: BCLO**).
3. Press the **(MAIN)** or **(SUB)** key to set this Menu Item to "ON" (thus activating the BCLO feature).
4. Press the **PTT** key to save the new setting and resume normal operation.

Misc Setup	: 1
BCLO	
	OFF

MIC MONITOR

The MIC Monitor feature allows you to monitor your voice signal when using the optional **VC-27** Earpiece/Microphone.

1. Connect the **VC-27** Earpiece/Microphone to the **MIC/SP** jack.
2. Press the **(MON F)** key, then press the **(SET 0)** key to enter the Set mode.
3. Rotate the **DIAL** to select the Menu Item labeled (**Misc Setup #19: MIC MONITOR**).
4. Press the **(MAIN)** or **(SUB)** key to set this Menu Item to "ON" (thus activating the MIC Monitor feature). The **VX-7R** exit from the Set mode.
5. The **VX-7R**'s internal microphone will now pick up the sound around the transceiver, then output its to the **VC-27** Earpiece/Microphone.
6. To disable the MIC Monitor feature, repeat steps 2 - 4, pressing the **(MAIN)** or **(SUB)** key to select "OFF," then press the **PTT** key.

Misc Setup	: 19
MIC MONITOR	
	OFF



*When this feature is activated without the **VC-27** Earpiece/Microphone connected, the **VX-7R** will develop a howling "feedback" condition.*

ADVANCED OPERATION

CHANGING THE TX DEVIATION LEVEL

In many areas of the world, channel congestion has required that operating channels be closely spaced. In such operating environments, it often is required that operators use reduced deviation levels, so as to reduce the potential for interference to users on adjacent channels. The **VX-7R** includes a simple method of accomplishing this:

1. Press the **MONF** key, then press the **SET** key to enter the Set mode.
2. Rotate the **DIAL** to select the Menu Item labeled (**Misc Setup #6: HALF DEVIATION**).
3. Press the **MAIN** or **SUB** key to change this setting to **ON**. In this configuration (**HALF DEVIATION** active), the transmitter's deviation will be approximately ± 2.5 kHz.
4. When you have made your selection, press the **PTT** key to save the new setting and exit to normal operation.

Misc Setup	:	6
HALF DEVIATION		
		OFF



The “normal” setting for the deviation (when this Menu Item is set to OFF) is ± 5 kHz.

downloaded by
www.radioamatore.info

MEMORY MODE

The **VX-7R** provides a wide variety of memory system resources. These include:

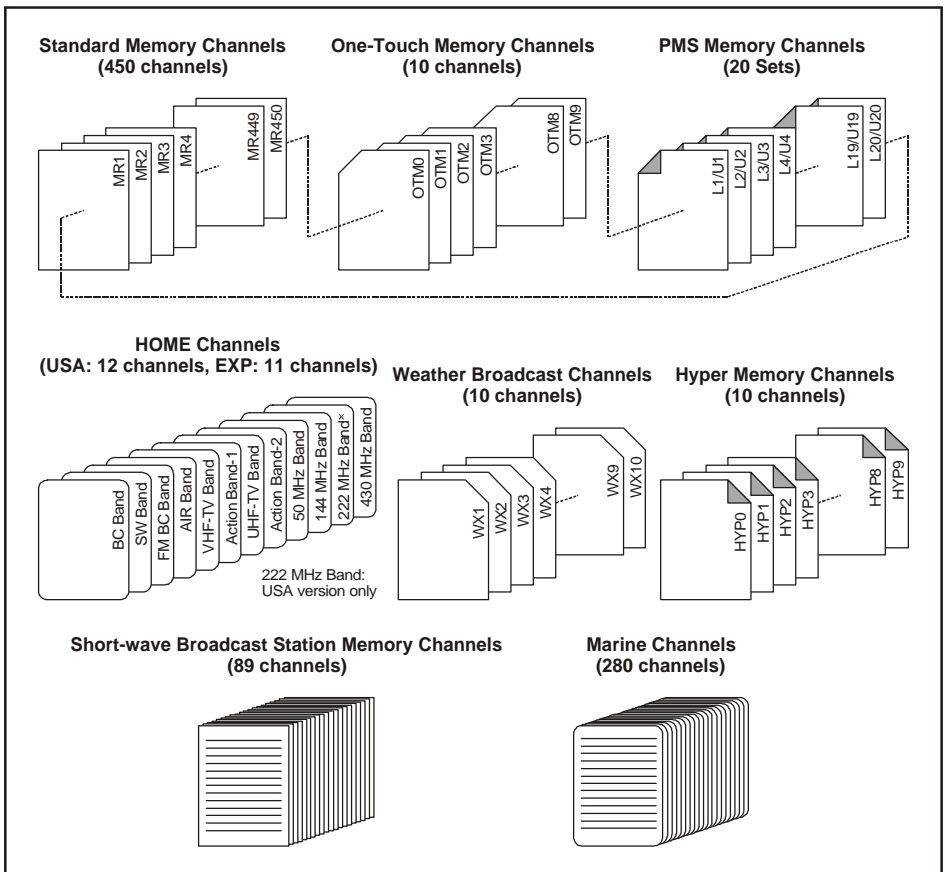

- Regular Memory Channels, which made up of:
 - 450 “Standard” memory channels, numbered “1” through “450.”
 - 12 (USA version) or 11 (EXP version) Home channels, providing storage and quick recall of one prime frequency on each operating band.
 - 20 sets of band-edge memories also known as “Programmable Memory Scan” channels, labeled “L1/U1” through “L20/U20.”
 - Nine Memory Groups, labeled “MG1” through “MG9.” Each Memory Group can be assigned 48 channels from the “standard” memory channel bank.
- Ten One-Touch Memory Channels
- Ten “Hyper-Memory” Channels
- Ten “Weather Broadcast” Channels
- 89 popular Short-wave Broadcast Station Memory Channels.
- 280 VHF Marine Channels.



MEMORY MODE

REGULAR MEMORY CHANNEL OPERATION

Memory Storage

1. Select the desired frequency, while operating in the VFO mode. Be sure to set up any desired CTCSS or DCS tones, as well as any desired repeater offset. The power level may also be set at this time, if you wish to store it.
2. Press and hold in the  key for 1/2 second.
3. Within five seconds of releasing the  key, rotate the **DIAL** to select the desired memory channel. The microprocessor will automatically select the next-available “free” channel (a memory register on which no data has been stored). If you see an Asterisk (*) by any channel number, it means that the channel currently has no data written on it (i.e. the channel is “free”).
4. Press the  key once more to store the frequency into memory.
5. You still will be operating in the “VFO” mode, so you may now enter other frequencies, and store them into additional memory locations, by repeating the above process.



VFO	145.280	
2 *		NFM
VFO	433.000	
		NFM
[W]	TSQ	



You may change the automatic memory channel selection feature to select the “next-highest memory channel above the last-stored memory channel” by instead of the “next-available ‘free’ channel” via the Menu Item labeled (Basic Setup #12 MW MODE); see page 85.

Storing Independent Transmit Frequencies (“Odd Splits”)

All memories can store an independent transmit frequency, for operation on repeaters with non-standard shift. To do this:



1. Store the receive frequency using the method already described under **MEMORY STORAGE** (it doesn’t matter if a repeater offset is active).
2. Turn to the desired transmit frequency, then press and hold in the  key for 1/2 second.
3. Within five seconds of releasing the  key, rotate the **DIAL** to select the same memory channel number as used in step “1” above.
4. Press and hold in the **PTT** switch, then press the  key once more momentarily while holding the **PTT** switch in (this does not key the transmitter).



Whenever you recall a memory which contains independently-stored transmit and receive frequencies, the “” indication will appear in the display.





REGULAR MEMORY CHANNEL OPERATION

Memory Recall

1. While operating in the VFO mode, press the  key to enter the Memory mode.
2. Rotate the **DIAL** to select the desired channel.
3. To return to the VFO mode, press the  key.

MR	145.280	
2		NFM
VFO	433.000	NFM
	TSQ	







1) When the radio is already set to the Memory mode, an easy way to recall memories is to key in the memory channel number, then press the  key. For example, to recall memory channel #14, press  →  → .

2) Memory channels on which you may have stored frequencies outside the amateur bands cannot be recalled on the SUB band.

HOME Channel Memory

A special one-touch “HOME” channel is available (one for each of the 12 (USA version) or 11 (EXP version) operating bands: see page 15), to allow quick recall of a favorite operating frequency on each band. Memory storage is simple to accomplish:

HM	146.520	
		NFM
VFO	433.000	NFM
		

1. Select the desired frequency, while operating in the VFO mode. Be sure to set up any desired CTCSS or DCS tones, as well as any desired repeater offset. The power level may also be set at this time, if you wish to store it.
2. Press and hold in the  key for 1/2 second.
3. While the memory channel number is blinking, just press the  key. The frequency and other data (if any) will now be stored in the special HOME channel register.
4. You may repeat this process on the other operating bands.
5. To recall the HOME channel, press the  key, then press the  key while operating either in the VFO or MR mode.



Note that the UHF HOME channel is the one used during “Emergency” operation. See page 39 for details regarding this feature.

MEMORY MODE

REGULAR MEMORY CHANNEL OPERATION

Labeling Memories

You may wish to append an alpha-numeric “Tag” (label) to a memory or memories, to aid in recollection of the channel’s use (such as a club name, etc.). This is easily accomplished using the Set mode.

1. Recall the memory channel on which you wish to append a label.
2. Press the **MONF** key, then press the **SET** key to enter the Set mode.
3. Rotate the **DIAL** to select the Menu Item labeled (**Basic Setup #11: NAME SET**).
4. Press the **RND DN** key momentarily to enable programming of the name tag.
5. Press the **MAIN**/**SUB** key, or one of the keyboard keys, to select the first digit of the desired label.

Basic Setup	:11
NAME SET	

Example 1: Press the **MONF** key, then press the **MAIN** or **SUB** key to select any of the 61 available characters.

Example 2: Press the **DW** key repeatedly to toggle among the seven available characters associated with that key: **A → B → C → a → b → c → 2**

6. Rotate the **DIAL** one click clockwise to move to the next character.
7. Repeat steps 4 and 5 to program the remaining letters, numbers, or symbols of the desired label. A total of eight characters may be used in the creation of a label.
8. When you have completed the creation of the label, press the **PTT** key to save the label and exit.

Basic Setup	:11
NAME SET	A,0
(Vertex)	







During “MR” (Memory Recall) operation, the alphanumeric Tag will appear below the frequency display. The alphanumeric Tag does not appear if you activate the Dual Receive Operation.

MR	145.280
2	(Vertex)
	TIME 10:00
Main	NFM
TSQ	<input checked="" type="checkbox"/>

REGULAR MEMORY CHANNEL OPERATION

Memory Offset Tuning

Once you have recalled a particular memory channel, you may easily tune off that channel, as though you were in the “VFO” mode.

1. With the **VX-7R** in the “MR” (Memory Recall) mode, select the desired memory channel.
2. Now press and hold in the  key for 1/2 second. The “MR” indicator will be replaced by one which says “MT” (“Memory Tuning”).
3. Rotate the **DIAL**, as desired, to tune to a new frequency. The synthesizer steps selected for VFO operation on the current band will be the steps used during Memory Tuning.
4. If you wish to return to the original memory frequency, press and hold in the  key for 1/2 second. The “MT” indicator will be replaced by “MR.”
5. If you wish to store a new frequency set during Memory Tuning, just press and hold in the  key for 1/2 second, per normal memory storage procedure. The microprocessor will automatically set itself to the next-available clear memory location, and you then press  again to lock in the new frequency.

MT	145.280	NFM
$\frac{2}{VFO}$	433.000	NFM
TSQ		<input checked="" type="checkbox"/>



*If you want to replace the original memory contents with those of the new frequency, be sure to rotate the **DIAL** to the original memory channel number!*

Any required CTCSS/DCS changes, or repeater offset modifications, must be done before storing the data into the new (or original) memory channel location.





downloaded by
www.radioamatore.info

MEMORY MODE

REGULAR MEMORY CHANNEL OPERATION

Masking Memories

There may be situations where you want to “Mask” memories so they are not visible during memory selection or scanning. For example, several memories used only in a city you visit infrequently may be stored, then “Masked” until you visit that city, at which time you can “Unmask” them for normal use.

1. Press the  key, if needed, to enter the MR mode.
2. Press and hold in the  key for 1/2 second, then rotate the **DIAL** to select the memory channel to be “Masked” from view.
3. Press the  key. The display will revert to memory channel #1. If you rotate the **DIAL** to the location you just “Masked,” you will observe that it is now invisible.
4. To Unmask the hidden memory, repeat the above procedure: press and hold in the  key for 1/2 second, rotate the **DIAL** to select the masked memory’s number, then press  to restore the memory channel’s data.



Watch out! You can manually store data over a “Masked” memory, deleting previous data, if you’re not careful. Use the “next available memory” technique (look for the [] icon) storage technique to avoid over-writing a masked memory.*

REGULAR MEMORY CHANNEL OPERATION

Memory Group Operation

Memory Group Assignment

1. Recall the memory channel to be assigned to a Memory Group.
2. Press and hold in the **MON F** key for 1/2 seconds, then press the numbered key (**SCAN** **7** ~) you want as the Memory Group for this channel.
3. Now memory channel data is copied into the Memory Group.

Memory Group Recall

1. Set the radio to the Memory mode on the “Main” Band by pressing the **WRITE MT** **V/M** key, if necessary.
2. Press the **MON F** key, then press the **SPCL** **9 99** key to recall the Special Memory Menu.
3. Rotate the **DIAL** knob to select the “2 MR Group” mode.
4. Press the **PTT** switch to activate the “*Memory Group*” mode.
5. Rotate the **DIAL** knob to select the desired Memory Group (“MG1” ~ “MG9”).
6. Press the **WRITE MT** **V/M** key momentarily to lock in the selected Memory Group.
7. In the Memory Group mode of operation, you can only select memory channels in the current memory group (up to 48 channels).
8. To change the Memory Group to another Group, press the **WRITE MT** **V/M** key momentarily, then rotate the **DIAL** knob.
9. To exit from Memory Group operation, recall the Special Memory Menu (press **SPCL** **9 99**) then change its setting to “1 OFF.”

Special Memory
<u>2</u> MR Group



MG1	145.280	NFM
₂		
VFO	433.000	NFM
TSQ		<input checked="" type="checkbox"/>

downloaded by
www.radioamatore.info

MEMORY MODE

Moving Memory Data to the VFO

Data stored on memory channels can easily be moved to VFO, if you like.

1. Select the memory channel containing the frequency data to be moved to VFO.
2. Press and hold in the  key for 1/2 second, then press the  key. The data will now have been copied to VFO, although the original memory contents will remain intact on the previously-stored channel.



If a Split Frequency Memory channel was transferred, the Tx frequency will be ignored (you will be set up for Simplex operation on the Receive frequency).

Memory Only Mode

Once memory channel programming has been completed, you may place the radio in a “Memory Only” mode, whereby VFO operation is impossible. This may be particularly useful during public-service events where a number of operators may be using the radio for first time, and ultimate simplicity of channel selection is desired.

To place the radio into the Memory Only mode, turn the radio off. Now press and hold in the  key while turning the radio on.

To return to normal operation, repeat the above power-on procedure.



downloaded by
www.radioamatore.info

HYPER MEMORY MODE

The **VX-7R** usually stores, into memory, the operating frequency and some aspects of operating status (such as CTCSS/DCS data, repeater shift, power level etc.). However, the “Hyper Memory” Mode allows you to store the total current configuration of the radio into a special “Hyper” memory bank.

For example, a Hyper Memory location may store the frequencies of both the “Main” and “Sub” bands, plus Spectrum Scope operational status, Scanning features, etc.







Hyper Memory Storage

1. Set up the transceiver according to the desired configuration, including parameters such as Spectrum Scope operation, PMS scanning, etc.
2. Press and hold in the numeric key ( through )^{SET}, corresponding to the Hyper Memory channel into which you wish to store this configuration, for 2 seconds.



In order to prevent accidental storage, the Hyper Memory Storage feature may be locked out via Menu Item (Basic Setup #14 HYPER WRITE).

Hyper Memory Recall

1. Press the  key, then press the  key, to recall the Special Memory Menu.
2. Rotate the **DIAL** knob to select the “4 HYP” mode.
3. Press the **PTT** switch to activate the “Hyper Memory” mode.
4. Press the appropriate numeric key ( through )^{SET} to recall the desired Hyper Memory channel.
5. To exit the Hyper Memory mode, recall the Special Memory Menu (press  + )^{SET}, then change its setting to “1 OFF.”



Special Memory
<u>4</u> HYP

HYP	446.000	NFM
1		
HYP	146.520	NFM
1		
	L3	☒



downloaded by
www.radioamatore.info

MEMORY MODE

ONE-TOUCH MEMORY MODE





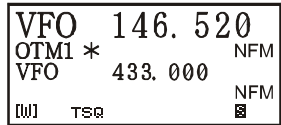

The One-Touch feature allows you to recall up to ten favorite frequencies directly via the numeric ( through ) keys.

One-Touch Memory Storage

1. Select the desired frequency, while operating in the VFO mode. Be sure to set up any desired CTCSS or DCS tones, as well as any desired repeater offset. The power level may also be set at this time, if you wish to store it.
2. Press and hold in the  key for 1/2 second.
3. Within five seconds of releasing the  key, rotate the **DIAL** to select the desired One-Touch Memory channel, which will be labeled “OTM0” through “OTM9.”
4. Press the  key once more to store the frequency into the selected One-Touch Memory.
5. You still will be operating in the “VFO” mode, so you may now enter other frequencies, and store them into additional One-Touch Memory locations, by repeating the above process.



One-Touch Memory Recall

1. Set the **VX-7R** to Mono band operation on the “Main” band.
2. Press the  key, then press the  key to recall the Special Memory Menu.
3. Rotate the **DIAL** knob to select the “3 OTM” mode.
4. Press the **PTT** switch to activate the “*One-Touch Memory*” mode.
5. Press the numeric key ( through ) corresponding to the One-Touch memory you wish to recall.
6. To exit the One-Touch Memory mode, recall the Special Memory Menu (press  + ) , then change its setting to “1 OFF.”

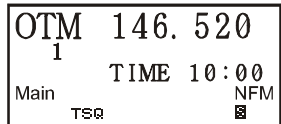
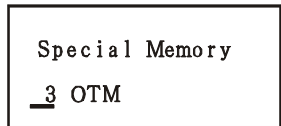

SHORT-WAVE BROADCAST STATION MEMORY CHANNELS

The Short-wave Broadcast Station Memory Channel Bank has been pre-programmed at the factory, for quick selection of broadcast stations.

1. Set the **VX-7R** to Mono band operation on the “Main” band.
2. Press the **(MON F)** key, then press the **(^{SPCL} 9 7)** key, to recall the Special Memory Menu.
3. Rotate the **DIAL** knob to select the “5 BC Station” mode.
4. Press the **PTT** switch to activate the “BC Station” mode.
5. Rotate the **DIAL** to select any of the 89 available Broadcast Stations.
6. To exit the BC Station mode, recall the Special Memory Menu (press **(MON F)** + **(^{SPCL} 9 7)**), then change its setting to “1 OFF.”

Special Memory

5 BC Station

LST 6. 030
1 VOA
Main TIME 10:00 AM

BROADCAST STATION FREQUENCY LIST

LST No.	Freq. (MHz)	MODE	Tag	Station Name	LST No.	Freq. (MHz)	MODE	Tag	Station Name
1	6.030	AM	VOA	Voice of America	45	7.270	AM	Spain	Radio Exterior de Espana
2	6.160	AM	VOA	Voice of America	46	9.520	AM	Spain	Radio Exterior de Espana
3	9.760	AM	VOA	Voice of America	47	11.920	AM	Spain	Radio Exterior de Espana
4	11.930	AM	VOA	Voice of America	48	15.585	AM	Spain	Radio Exterior de Espana
5	5.995	AM	Canada	Radio Canada International	49	6.090	AM	Luxembrg	Radio Luxembourg
6	7.235	AM	Canada	Radio Canada International	50	7.485	AM	Norway	Radio Norway International
7	9.735	AM	Canada	Radio Canada International	51	9.590	AM	Norway	Radio Norway International
8	11.705	AM	Canada	Radio Canada International	52	9.985	AM	Norway	Radio Norway International
9	6.195	AM	BBC	British Broadcasting Corporation	53	13.800	AM	Norway	Radio Norway International
10	9.410	AM	BBC	British Broadcasting Corporation	54	6.065	AM	Sweden	Radio Sweden
11	12.095	AM	BBC	British Broadcasting Corporation	55	9.490	AM	Sweden	Radio Sweden
12	15.310	AM	BBC	British Broadcasting Corporation	56	13.625	AM	Sweden	Radio Sweden
13	6.045	AM	France	Radio France International	57	17.055	AM	Sweden	Radio Sweden
14	9.790	AM	France	Radio France International	58	6.120	AM	Finland	Radio Finland
15	11.670	AM	France	Radio France International	59	9.630	AM	Finland	Radio Finland
16	15.525	AM	France	Radio France International	60	11.755	AM	Finland	Radio Finland
17	3.955	AM	DW	Deutsche Welle	61	9.795	AM	Finland	Radio Finland
18	6.075	AM	DW	Deutsche Welle	62	5.940	AM	Russia	Voice of Russia
19	9.545	AM	DW	Deutsche Welle	63	5.920	AM	Russia	Voice of Russia
20	9.735	AM	DW	Deutsche Welle	64	7.205	AM	Russia	Voice of Russia
21	6.060	AM	Italy	Italian Radio International	65	12.030	AM	Russia	Voice of Russia
22	7.175	AM	Italy	Italian Radio International	66	9.435	AM	Israel	Israel Broadcasting Authority
23	9.515	AM	Italy	Italian Radio International	67	11.585	AM	Israel	Israel Broadcasting Authority
24	17.710	AM	Italy	Italian Radio International	68	15.615	AM	Israel	Israel Broadcasting Authority
25	3.985	AM	Swiss	Swiss Radio International	69	17.545	AM	Israel	Israel Broadcasting Authority
26	6.165	AM	Swiss	Swiss Radio International	70	6.045	AM	India	All India Radio (AIR)
27	9.885	AM	Swiss	Swiss Radio International	71	9.595	AM	India	All India Radio (AIR)
28	15.220	AM	Swiss	Swiss Radio International	72	11.620	AM	India	All India Radio (AIR)
29	5.985	AM	Belgium	Radio Vlaanderen International	73	15.020	AM	India	All India Radio (AIR)
30	9.925	AM	Belgium	Radio Vlaanderen International	74	7.190	AM	China	China Radio International (CRI)
31	11.780	AM	Belgium	Radio Vlaanderen International	75	5.250	AM	China	China Radio International (CRI)
32	13.740	AM	Belgium	Radio Vlaanderen International	76	9.855	AM	China	China Radio International (CRI)
33	5.955	AM	Holland	Radio Nederland	77	11.685	AM	China	China Radio International (CRI)
34	6.020	AM	Holland	Radio Nederland	78	5.975	AM	Korea	Radio Korea
35	9.895	AM	Holland	Radio Nederland	79	7.275	AM	Korea	Radio Korea
36	11.655	AM	Holland	Radio Nederland	80	9.570	AM	Korea	Radio Korea
37	9.590	AM	Denmark	Radio Denmark	81	13.670	AM	Korea	Radio Korea
38	9.985	AM	Denmark	Radio Denmark	82	6.155	AM	Japan	Radio Japan
39	13.800	AM	Denmark	Radio Denmark	83	7.200	AM	Japan	Radio Japan
40	15.735	AM	Denmark	Radio Denmark	84	9.750	AM	Japan	Radio Japan
41	9.780	AM	Portugal	Radio Portugal	85	11.850	AM	Japan	Radio Japan
42	11.960	AM	Portugal	Radio Portugal	86	5.995	AM	Australi	Radio Australia
43	15.555	AM	Portugal	Radio Portugal	87	9.580	AM	Australi	Radio Australia
44	21.655	AM	Portugal	Radio Portugal	88	9.660	AM	Australi	Radio Australia
					89	12080	AM	Australi	Radio Australia

MEMORY MODE

VHF MARINE MEMORY CHANNELS

The VHF Marine Channel Bank has been pre-programmed at the factory, for quick selection.

1. Set the **VX-7R** to Mono band operation on the “Main” band.
2. Press the **MONF** key, then press the **SPCL** key, to recall the Special Memory Menu.
3. Rotate the **DIAL** knob to select the “6 Marine” mode.
4. Press the **PTT** switch to activate the “*VHF Marine Channel*” mode.
5. Rotate the **DIAL** to select any of the 280 available VHF Marine Channels.
6. To exit the VHF Marine Channel mode, recall the Special Memory Menu (press **MONF** + **SPCL**), then change its setting to “1OFF.”

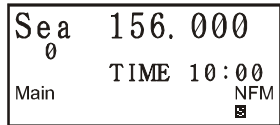
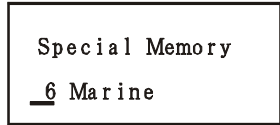

VHF MARINE CHANNEL FREQUENCY LIST

CH No.	Frequency (MHz)	CH No.	Frequency (MHz)	CH No.	Frequency (MHz)	CH No.	Frequency (MHz)	CH No.	Frequency (MHz)	CH No.	Frequency (MHz)	CH No.	Frequency (MHz)
0	156.000	41	158.050	82	157.125	123	159.075	164	160.100	205	161.125	246	155.875
1	156.050	42	158.100	83	157.175	124	159.100	165	160.125	206	161.150	247	155.850
2	156.100	43	158.150	84	157.225	125	159.125	166	160.150	207	161.175	248	155.825
3	156.150	44	158.200	85	157.275	126	159.150	167	160.175	208	161.200	249	155.800
4	156.200	45	158.250	86	157.325	127	159.175	168	160.200	209	161.225	250	155.775
5	156.250	46	158.300	87	157.375	128	159.200	169	160.225	210	161.250	251	155.750
6	156.300	47	158.350	88	157.425	129	159.225	170	160.250	211	161.275	252	155.725
7	156.350	48	158.400	89	157.475	130	159.250	171	160.275	212	161.300	253	155.700
8	156.400	49	158.450	90	157.525	131	159.275	172	160.300	213	161.325	254	155.675
9	156.450	50	158.500	91	157.575	132	159.300	173	160.325	214	161.350	255	155.650
10	156.500	51	158.550	92	157.625	133	159.325	174	160.350	215	161.375	256	155.625
11	156.550	52	158.600	93	157.675	134	159.350	175	160.375	216	161.400	257	155.600
12	156.600	53	158.650	94	157.725	135	159.375	176	160.400	217	161.425	258	155.575
13	156.650	54	158.700	95	157.775	136	159.400	177	160.425	218	161.450	259	155.550
14	156.700	55	158.750	96	157.825	137	159.425	178	160.450	219	161.475	260	155.525
15	156.750	56	158.800	97	157.875	138	159.450	179	160.475	220	161.500	261	155.500
16	156.800	57	158.850	98	157.925	139	159.475	180	160.500	221	161.525	262	155.475
17	156.850	58	158.900	99	157.975	140	159.500	181	160.525	222	161.550	263	155.450
18	156.900	59	158.950	100	158.025	141	159.525	182	160.550	223	161.575	264	155.425
19	156.950	60	156.025	101	158.075	142	159.550	183	160.575	224	161.600	265	155.400
20	157.000	61	156.075	102	158.125	143	159.575	184	160.600	225	161.625	266	155.375
21	157.050	62	156.125	103	158.175	144	159.600	185	160.625	226	161.650	267	155.350
22	157.100	63	156.175	104	158.225	145	159.625	186	160.650	227	161.675	268	155.325
23	157.150	64	156.225	105	158.275	146	159.650	187	160.675	228	161.700	269	155.300
24	157.200	65	156.275	106	158.325	147	159.675	188	160.700	229	161.725	270	155.275
25	157.250	66	156.325	107	158.375	148	159.700	189	160.725	230	161.750	271	155.250
26	157.300	67	156.375	108	158.425	149	159.725	190	160.750	231	161.775	272	155.225
27	157.350	68	156.425	109	158.475	150	159.750	191	160.775	232	161.800	273	155.200
28	157.400	69	156.475	110	158.525	151	159.775	192	160.800	233	161.825	274	155.175
29	157.450	70	156.525	111	158.575	152	159.800	193	160.825	234	161.850	275	155.150
30	157.500	71	156.575	112	158.625	153	159.825	194	160.850	235	161.875	276	155.125
31	157.550	72	156.625	113	158.675	154	159.850	195	160.875	236	161.900	277	155.100
32	157.600	73	156.675	114	158.725	155	159.875	196	160.900	237	161.925	278	155.075
33	157.650	74	156.725	115	158.775	156	159.900	197	160.925	238	161.950	279	155.050
34	157.700	75	-	116	158.825	157	159.925	198	160.950	239	161.975	280	155.025
35	157.750	76	-	117	158.875	158	159.950	199	160.975	240	162.000	281	155.000
36	157.800	77	156.875	118	158.925	159	159.975	200	161.000	241	162.025		
37	157.850	78	156.925	119	158.975	160	160.000	201	161.025	242	155.975		
38	157.900	79	156.975	120	159.000	161	160.025	202	161.050	243	155.950		
39	157.950	80	157.025	121	159.025	162	160.050	203	161.075	244	155.925		
40	158.000	81	157.075	122	159.050	163	160.075	204	161.100	245	155.900		

The **VX-7R** allows you to scan just the memory channels, the entire operating band, or a portion of that band. It will halt on signals encountered, so you can talk to the station(s) on that frequency, if you like.

Scanning operation is basically the same in each of the above modes. Before you begin, take a moment to select the way in which you would like the scanner to resume scanning after it halts on a signal.

Setting the Scan-Resume Technique

Three options for the Scan-Resume mode are available:

3 SEC/5 SEC/10 SEC: In this mode, the scanner will halt on a signal it encounters, and will hold there for the selected resume time. If you do not take action to disable the scanner within that time period, the scanner will resume even if the stations are still active.

BUSY: In this mode, the scanner will halt on a signal it encounters. Two seconds after the carrier has dropped because the other station(s) ceased transmission, the scanner will resume. In the case of constant-carrier signals like Weather Station broadcasts, the scanner will likely remain on this frequency indefinitely.

HOLD: In this mode, the scanner will halt on a signal it encounters. It will not restart automatically; you must manually re-initiate scanning if you wish to resume.

To set the Scan-Resume mode:

1. Press the **(MON F)** key, then press the **(SET 0)** key to enter the Set mode.
2. Rotate the **DIAL** to select the Menu Item labeled (**Scan Modes #3: RESUME**).
3. Press the **(MAIN)** or **(SUB)** key to select the desired scan-resume mode.
4. When you have made your selection, press the **PTT** key to save the new setting and exit to normal operation.

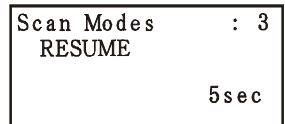

The default condition for this Menu Item is “5 SEC.”

Setting the Squelch Level during active Scanning operation

The **VX-7R** allows adjustment of the Squelch level “on the fly” while you are scanning.



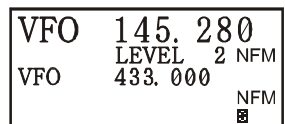

1. While the scanner is engaged, press the **(MON F)** key, then press the **(SET 0)** key (the current squelch level will appear below the frequency display).
2. Rotate the **DIAL** to select the desired Squelch level.
3. Press the **PTT** switch momentarily to save the new setting and exit to normal operation. In this case, pressing the **PTT** switch this one time will not causing scanning to stop.



SCANNING

VFO SCANNING

This mode allows you to scan the entire current operating band.

1. Select the VFO mode by pressing the  key, if necessary.
2. Press the  key, then press the  key to start scanning.
3. If and when the scanner encounters a signal strong enough to open the squelch, the scanner will halt temporarily; the decimal point of the frequency display will blink during this “Pause” condition.
4. The scanner will then resume according to the Scan-Resume mode selected in the previous section.
5. To cancel scanning, press the **PTT** or  key.







*When you start scanning, the VX-7R will be changing frequency in the upward direction. If you want to change direction of the scan while it is underway, rotate the **DIAL** one click in the opposite direction (in this case, one click counter-clockwise). You'll see the scanner turn around and change frequency downward!*

You may change the scanning operation so that the VFO frequency will jump to the low band edge of the *next band* when the VFO frequency reaches the high edge of the current band (or vice versa). See page 95 regarding Menu Item (**Misc Setup #10 VFO MODE**).

MEMORY SCANNING

Memory scanning is similarly easy to initiate:

1. Set the radio to the Memory mode by pressing the  key, if necessary.
2. Press the  key, then press the  key to initiate scanning.
3. As with VFO scanning, the scanner will halt on any signal encountered that is strong enough to open the squelch; it will then resume scanning according to the Scan-Resume mode set previously.
4. To cancel scanning, press the **PTT** or  key.



On the “Sub” band, Memory Channel scan will search through only the memory channels which are stored inside the amateur bands.

MEMORY SCANNING

Temporary Memory Skip

If the scanner repeatedly stops on a channel due to temporary noise or interference, you can temporarily mark it to be skipped (except for Memory Channel “1”). The channel will be skipped until you manually stop the scan (by pressing the **PTT** switch, for example).

To skip a channel temporarily, press the **MON F** key, then press the **WRITE MT** key while the scanner has stopped on the channel to be skipped. The scanner will instantaneously resume, and that channel will not be scanned during this scanning session.

How to Skip (Omit) a Channel During Memory Scan Operation

As mentioned previously, some continuous-carrier stations like a Weather Broadcast station will seriously impede scanner operation if you are using the “Carrier Drop” Scan-Resume mode, as the incoming signal will not pause long enough for the transceiver to resume scanning. Such channels may be “Skipped” during scanning, if you like:

1. Set the radio to the Memory Mode by pressing the **WRITE MT** key, if necessary.
2. Rotate the **DIAL** to select the Memory Channel to be skipped during scanning.
3. Press the **MON F** key, then press the **SET** key to enter the Set mode.
4. Rotate the **DIAL** to select the Menu Item labeled (**Basic Setup #13: MEMO SCAN MODE**).
5. Press the **MAIN** or **SUB** key so as to select “SKIP.” The current Memory Channel will now be ignored during scanning. The “PREFERENTIAL” selection is used for “Preferential Memory Scan,” described in the next column.
6. When you have made your selection, press the **PTT** key to save the settings and exit to normal operation.

Basic Setup	:13
MEMO SCAN MODE	
OFF	

A small “◀” icon will appear when you recall the “skipped” memory channel manually.

To re-institute a channel into the scanning loop, select “OFF” in step 5 above (the “Skipped” channel will, of course, still be accessible via manual channel selection methods using the **DIAL** in the MR mode, whether or not it is locked out of the scanning loop).





MR	◀146.520	NFM
2		
VFO	433.000	NFM
		☑

MEMORY SCANNING

Preferential Memory Scan



The **VX-7R** also allows you to set up a “Preferential Scan List” of channels which you can “flag” within the memory system. These channels are designated by a “♪” icon when you have selected them, one by one, for the Preferential Scan List. When you initiate memory scanning on a channel with the “♪” icon appended, only those channels bearing the “♪” icon will be scanned. If you initiate scanning on a channel which does not have the “♪” icon appended, you will scan all channels including those with the “♪” icon appended.

1) Here is the procedure for setting up and using the Preferential Scan List:

1. Press the  key momentarily to enter the Memory Recall mode, if you are not using memories already.
2. Rotate the **DIAL** to select the channel which you wish to add to the Preferential Scan List.
3. Press the  key, then press the  key to enter the Set mode.
4. Rotate the **DIAL** to select the Menu Item labeled (**Basic Setup #13: MEMO SCAN MODE**).
5. Press the  or  key so as to select “PREFERENTIAL.”
6. When you have made your selection, press the **PTT** key to save the settings and exit to normal operation.

Basic Setup	:13
MEMO SCAN MODE	
OFF	



2) To initiate Preferential Memory Scan:

1. Press the  key momentarily to enter the Memory Recall mode, if you are not using memories already.
2. Rotate the **DIAL** to select any channel which has an “♪” icon appended to the channel number.
3. Press the  key, then press the  key to initiate Preferential Memory Scanning. Only the channels which have an “♪” icon appended to the channel number will be scanned.

MR	♪145. 260	NFM
3		
VFO	433. 000	NFM
		☒

PROGRAMMABLE (BAND LIMIT) MEMORY SCAN (PMS)

This feature allows you to set sub-band limits for either scanning or manual VFO operation. For example, you might wish to set up a limit (in North America) of 144.300 MHz to 148.000 MHz so as to prevent encroachment into the SSB/CW “Weak Signal” portion of the band below 144.300 MHz. Here’s how to do this:

1. Set the radio to the VFO mode by pressing the  key, if necessary.
2. Using the techniques learned earlier, store (per the above concept) 144.300 MHz into Memory Channel #L1 (the “L” designates the Lower sub-band limit).
3. Likewise, store 148.000 MHz into Memory Channel #U1 (the “U” designates the Upper sub-band limit).
4. Switch to the Memory mode by pressing the  key once, then rotate the **DIAL** to select Memory Channel #L1.
5. Press and hold in the  key for 1/2 second to start PMS operation; the “MR” label will be replaced by “PMS” in the upper left-hand corner of the display. Tuning and scanning will now be limited within the just-programmed range.
6. 20 pairs of Band Limit memories, labeled L1/U1 through L20/U20 are available. You therefore can set upper and lower operation limits on a number of bands, if you like.





MR	144.300	NFM
L 1		
VFO	433.000	NFM
		<input checked="" type="checkbox"/>

PMS	144.300	NFM
L 1		
VFO	433.000	NFM
		<input checked="" type="checkbox"/>

“PRIORITY CHANNEL” SCANNING (DUAL WATCH)

The **VX-7R**’s scanning features include a two-channel scanning capability which allows you to operate on a VFO or Memory channel, while periodically checking a user-defined Memory Channel for activity. If a station is received on the Memory Channel which is strong enough to open the Squelch, the scanner will pause on that station in accordance with the Scan-Resume mode set via Menu Item (**Scan Modes #3: RESUME**). See page 56.

Here is the procedure for activating Priority Channel Dual Watch operation:

1. Press the  key momentarily to enter the Memory Recall mode, if you are not using memories already.
2. Press and hold in the  key for 1/2 second, then select the memory channel you wish to be the “Priority” channel.
3. Press the  key. When rotate the **DIAL** to select the “Priority” channel, a “P” icon (for the “Main” band priority channel) or “p” icon (for the “Sub” band priority channel) will appear to the right of the “MR” icon, indicating it is the Priority channel.
3. Now set the **VX-7R** for operation on another memory channel, or on a VFO frequency.
4. Press the  key, then press the  key. The display will remain on the VFO or memory channel selected, but every five seconds the **VX-7R** will check the Priority Channel for activity.

VFO	145.000	NFM
VFO	433.000	NFM
DW		<input checked="" type="checkbox"/>

SCANNING

AUTOMATIC LAMP ILLUMINATION ON SCAN STOP

The **VX-7R** will automatically illuminate the LCD Lamp whenever the scanner stops on a signal; this allows you to see the frequency of the incoming signal better at night. Note that this will, of course, increase the battery consumption, so be sure to switch it off during the day (the default condition for this feature is “ON”).

The procedure for disabling the Scan Lamp is:

1. Press the **(MONF)** key, then press the **(SET 0)** key to enter the Set mode.
2. Rotate the **DIAL** to select the Menu Item labeled (**Scan Modes #4: SCAN LAMP**).
3. Press the **(MAIN)** or **(SUB)** key to set this Menu Item to **OFF**.
4. When you have made your selection, press the **PTT** to save the new setting and exit to normal operation.

Scan Modes	: 4
SCAN LAMP	
	ON

BAND EDGE BEEPER

The **VX-7R** will automatically “beep” when a band edge is encountered during scanning (either in standard VFO scanning or during PMS operation). You may enable this feater (band edge beeper) when the frequency reaches the band edge while selecting the VFO frequency by the **DIAL**.

The procedure for disabling the Band-Edge Beeper is:

1. Press the **(MONF)** key, then press the **(SET 0)** key to enter the Set mode.
2. Rotate the **DIAL** to select the Menu Item labeled (**Scan Modes #2: EDGE BEEP**).
3. Press the **(MAIN)** or **(SUB)** key to set this Menu Item to **ON**.
4. When you have made your selection, press the **PTT** to save the new setting and exit to normal operation.

Scan Modes	: 2
EDGE BEEP	
	OFF

downloaded by
www.radioamatore.info

SPECTRUM ANALYZER OPERATION

The Spectrum Analyzer allows viewing operating activity on channels above or below the current operating channel in the VFO mode.

The display indicates the relative signal strength on channels immediately adjacent to the current operating frequency.





The Spectrum Analyzer feature can only be activated while the VX-7R is operating in the Mono band mode.

Two basic operating modes for Spectrum Analyzer are available:







- 1: In this mode, the transceiver sweeps the current band once.
- CONTINUOUS:** In this mode, the transceiver sweeps the current band repeatedly until pressing the  key, or the Spectrum Analyzer is turned off.

Setting up the Spectrum Analyzer mode:

1. Press the  key, then press the  key to enter the Set mode.
2. Rotate the **DIAL** to select the Menu Item labeled (Scan Modes 6: SPEC-ANALYZER1).
3. Rotate the **DIAL** to select the desired Spectrum Analyzer mode (see above).
4. When you have made your selection, press the **PTT** to save the new setting and exit to normal operation.

Scan Modes	:	6
SPEC-ANALYZER	:	1
1		

To activate the Spectrum Analyzer:

1. Set the radio to the VFO mode in the “Mono” band mode.
2. Press the  key, then press the  key to activate the Spectrum Analyzer.
3. When the Spectrum Analyzer is activated, press the  or  key to change the visible bandwidth. Available selections are ± 5 , ± 8 , ± 14 , ± 29 , and ± 60 channels (default: ± 5 channels). The visible bandwidth, however, depends on the selected channel step size, so match the default channel steps with the amateur band you are using.
4. To turn the Spectrum Analyzer off and operate on the centered (and displayed) channel, press the  key to stop the sweep, if needed, then press the  key followed by  key.



Audio output normally is interrupted during Spectrum Analyzer operation. You may enable the audio output of the signal on the center frequency (▼) when the Spectrum Analyzer is activated in the Amateur band via Menu Item (Scan Modes #7 SPEC-ANALYZER 2). See page 90 for details.

SMART SEARCH OPERATION

The Smart Search feature allows you to load frequencies automatically according to where activity is encountered by your radio. When Smart Search is engaged, the transceiver will search above and below your current frequency, storing active frequencies as it goes (without stopping on them even momentarily); these frequencies are stored into a special Smart Search memory band, consisting of 31 memories (15 above the current frequency, 15 below the current frequency, plus the current frequency itself).

Two basic operating modes for Smart Search are available:

- 1: In this mode, the transceiver will sweep the current band once in each direction starting on the current frequency. All channels where activity is present will be loaded into the Smart Search memories; whether or not all 31 memories are filled, the search will stop after one sweep in each direction.

CONTINUOUS: In this mode, the transceiver will make one pass in each direction as with One-Shot searching; if all 31 channels are not filled after the first sweep, however, the radio will continue sweeping until they are all filled.



The Smart Search feature can only be activated while the VX-7R is operating in the Mono band mode.





Setting the Smart Search Mode

1. Press the **(MONF)** key, then press the **(SET)** key to enter the Set mode.
2. Rotate the **DIAL** to select the Menu Item labeled (**Scan Mode #5: SMART SEARCH**).
3. Press the **(MAIN)** or **(SUB)** key to select the desired Smart Search mode (see above).
4. When you have made your selection, press the **PTT** to save the new setting and exit to normal operation.

Scan Modes	: 5
SMART SEARCH	
1	

downloaded by
www.radioamatore.info

Storing Smart Search Memories

1. Set the radio to the VFO mode in the “Mono” band mode. Be sure that you have the Squelch adjusted properly (so that band noise is quieted).
2. Press the  key, then press the  key to enter the Smart Search mode.
3. Press the  key to begin Smart Search scanning.
4. As active channels are detected, you will observe the number of “loaded” channels increasing in the regular memory channel window.
5. Depending on the mode you set for Smart Search operation (“1” or “CONTINUOUS”), the Smart Search scan will eventually terminate, and the LCD will revert to Smart Search Memory Channel “C.”
6. To recall the Smart Search memories, rotate the **DIAL** to choose from among the Smart Search memories.
7. To return to normal operation, press the  key, then press the  key.

SMRT	146.520	
C		NFM
VFO	433.000	NFM
		5



*Smart Search is a great tool when visiting a city for the first time. You don't need to spend hours looking up repeater frequencies from a reference guidebook...just ask your **VX-7R** where the action is!*

downloaded by
www.radioamatore.info

CHANNEL COUNTER OPERATION

The Channel Counter allows measuring of the frequency of a nearby transmitter, without knowing that frequency in advance. The frequency can be measured by bringing the **VX-7R** close to the transceiver which is transmitting.

The **VX-7R** performs a high-speed search within a ± 5 MHz range from the frequency displayed on the LCD. When the strongest signal in that range is identified, the **VX-7R** displays the frequency of that (strongest) signal, and writes it into the special “Channel Counter” memory.

Note: This Channel Counter is designed to provide an *indication* of the operating frequency of the incoming signal, one that is close enough to allow the user to tune precisely to the other station’s frequency. This feature is not, however, designed to provide a precise determination of the other station’s frequency.



The Channel Counter feature can only be activated while the VX-7R is operating in the Mono band mode.

1. Set the radio to the VFO mode in the predicted frequency range for the transmitter to be measured with the “Mono” band mode engaged.
2. Bring the **VX-7R** into close proximity to the transmitter to be measured.
3. Press the **(MON F)** key, then press the **(CH CNT)** key to activate the Channel Counter; the frequency of the nearby station will be displayed. When the channel counter is active, a 50 dB receiver front-end attenuator will be engaged. Therefore, only stations in close proximity may have their frequencies measured using this feature.
4. If it isn’t possible to determine the signal’s frequency, the transceiver will return to the frequency on which you were operating when you started Channel Counter operation.
5. When you are finished, press the **(MON F)** key, then press the **(CH CNT)** key. The radio will exit from Channel Counter operation.

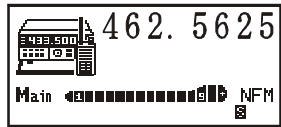

Setting the Channel Counter Sweep Width

You may change the bandwidth of the Channel Counter. Available selections are ± 5 , ± 10 , ± 50 , and ± 100 MHz (default: ± 5 MHz).

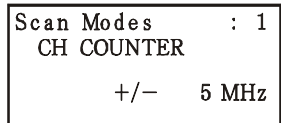

Here is the procedure for setting the Channel Counter Bandwidth:

1. Press the **(MON F)** key, then press the **(SET 0)** key to enter the Set mode.
2. Rotate the **DIAL** to select the Menu Item labeled (**Scan Modes #1: CH COUNTER**).
3. Press the **(MAIN)** or **(SUB)** key to select the desired bandwidth.
4. When you have made your selection, press the **PTT** to save the new setting and exit to normal operation.



INTERNET CONNECTION FEATURE

The **VX-7R** can be used to access the repeater which provide the Vertex Standard **WIRES™** (Wide-Coverage Internet Repeater Enhancement System).

1. Press the  key to activate the Internet Connection feature. The “” icon will appear in the upper left corner of the display.
2. Rotate the **DIAL**, while pressing and holding in the  key, to select the access number corresponding to the **WIRES™** repeater to which you wish to establish an Internet link (ask your repeater owner/operator if you don't know the access numbers in the network). Now press the **PTT** switch to exit from the selection mode.

INTERNET

— 1
3. With the Internet Connection feature activated (as in step 1 above), the **VX-7R** will generate a brief (0.1 second) DTMF tone according to your selection in step 2. This DTMF tone is sent at the beginning of every transmission to establish or maintain the link to the remote **WIRES™** repeater.
4. To disable the Internet Connection feature, press the  key again.

downloaded by
www.radioamatore.info

SENSOR MODE

The **VX-7R** can display various information provided by internal sensors. Available selections are “Current Time,” “Battery Voltage,” “Temperature,” and “Audio Wave-form.” Also, when the optional Barometric Pressure unit (**SU-1**) is installed, you get the unique capability of providing readout of the current barometric pressure. This information is then used for calculation of your current altitude and weather forecast.

The Barometric Pressure unit requires calibration of the “offset” parameters, so that differences in pressure can be used to calculate altitude. This procedure requires that you have a calculated barometer, and that you know your current altitude. If you are at sea level, of course, the latter parameter requires no research.



The Sensor mode can only display while the VX-7R is operating in the Mono band mode (except the Weather Forecast mode). The internal sensor measures continuously unless the Sensor mode is disabled.

To display the sensor information:

1. Press the **[MONF]** key, then press the **[SET 0]** key to enter the Set Mode.

2. Rotate the **DIAL** to select the Menu Item labeled (Measurements #1: **SENSOR DISPLAY**).



3. Press the **[MAIN]** or **[SUB]** key to select the sensor mode you wish to display.

TIME: Indicates the current time.

DC: Indicates the battery voltage and battery type.

TEMP: Indicates the current temperature inside the transceiver’s case.

WAVE: Depicts the (RX and TX) audio waveform.

BARO: Indicates the Barometric Pressure and relative changes in the pressure (two bars per hours) (requires **SU-1**).

ALTI: Indicates the Altitude (requires **SU-1**)

WX: Indicates the Weather Forecast (requires **SU-1**).

OFF: Disables the sensor information.

4. Press the **PTT** key momentarily to exit to normal operation and display the sensor information on the display.

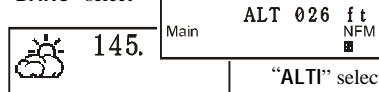
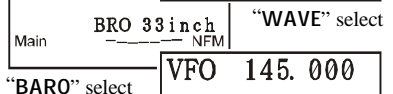
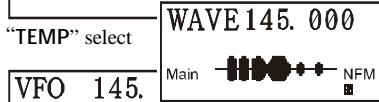
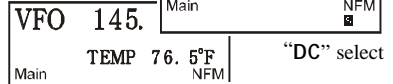
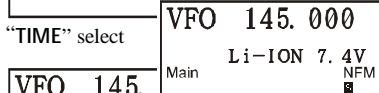
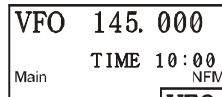

To disable the display of sensor information, repeat the above procedure, pressing the **[MAIN]** or **[SUB]** key to select **OFF** in step 3 above.



1) The VX-7R's Weather Forecast feature will only work properly if the altitude remains constant.

2) The VX-7R's Weather Forecast feature will not be accurate when in the immediate vicinity of an approaching hurricane/typhoon, on the boundary of a stationary front, etc.

3) The VX-7R's Weather Forecast feature is designed to be a supplemental aid for the information of the user. It must not be relied upon as a primary weather forecasting tool, and Vertex Standard is not responsible for any damage or other liability arising from its use.

SENSOR MODE OPTIONS

Clock Set

The VX-7R has a 24-hour clock with a calendar which covers all dates from January 1, 2000 through December 31, 2099 (accuracy: ± 30 sec/month).

To set the clock:

1. Press the **MON F** key, then press the **SET** key to enter the Set mode.
2. Rotate the **DIAL** knob to select the Menu Item labeled (Misc Setup #16: TIME SET).
3. Press the **BND DN BAND** key to enable setting of this Menu Item.
4. Press the **MAIN** or **SUB** key to select the "year" setting.
5. Rotate the **DIAL** one click clockwise, then press the **MAIN** or **SUB** key to select the "month" setting.
6. Repeat the above step to set the "day," "day of the week," "hour," and "minute" selections.
7. Rotate the **DIAL** one click clockwise, then press the **MAIN** or **SUB** key to select "Timer Signal" On (SIG) or Off (-).
8. Rotate the **DIAL** one click clockwise, press the **WRITE MT W/M** key to start the clock from "00" seconds.
9. When you have finished the time setup, press the **PTT** key to save the new setting and return to normal operation.

Misc Setup	: 16
TIME SET	
2000. 01. 01	MON



The VX-7R's has a rechargeable Li-Ion battery cell used just for the clock. Therefore, the VX-7R can maintain its clock data for approximately two months without using the main battery pack or external DC power.

SENSOR MODE

SENSOR MODE OPTIONS

Selecting the Wave-Form Display

1. Press the **MONF** key, then press the **SET 0** key to enter the Set Mode.
2. Rotate the **DIAL** to select the Menu Item labeled (Measurements #2: WAVE MONITOR).
3. Press the **MAIN** or **SUB** key to select the desired wave form (RX SIGNAL, TX MODULATION, or All).
4. Press the **PTT** key momentarily to save the new setting and exit to normal operation.

Measurements	: 2
WAVE MONITOR	
ALL	

Selecting the Units of Temperature Display

1. Press the **MONF** key, then press the **SET 0** key to enter the Set Mode.
2. Rotate the **DIAL** to select the Menu Item labeled (Measurements #3: TEMP UNIT).
3. Press the **MAIN** or **SUB** key to select the preferred unit (°C or °F).
4. Press the **PTT** key momentarily to save the new setting and exit to normal operation.

Measurements	: 3
TEMP UNIT	
°F	

Selecting the Unit of Atmospheric Pressure Meter (Barometer)

1. Press the **MONF** key, then press the **SET 0** key to enter the Set Mode.
2. Rotate the **DIAL** to select the Menu Item labeled (Measurements #4: BARO UNIT).
3. Press the **MAIN** or **SUB** key to select the preferred unit (hpa/mbar/mmHg/inch).
4. Press the **PTT** key momentarily to save the new setting and exit to normal operation.

Measurements	: 4
BARO UNIT	
inch	

Correcting the Atmospheric Pressure Meter (Barometer Offset)

1. Press the **MONF** key, then press the **SET 0** key to enter the Set Mode.
2. Rotate the **DIAL** to select the Menu Item labeled (Measurements #5: BARO OFFSET).
3. Press the **BND DN BAND TX PDLK** key to enable setting of this Menu Item.
4. Press the **S** key to indicate the barometer data in “hpa” units.
5. Press the **MAIN** or **SUB** key to adjust the **VX-7R** display to the *calibrated* barometer value in the “hpa” units.
6. Press the **WRITE MT V/M** key to save the new setting.
7. Press the **PTT** key momentarily to exit to normal operation.

Measurements	: 5
BARO OFFSET	
BARO1029hPa	

SENSOR MODE OPTIONS

Selecting the Units of Altitude

1. Press the **MON F** key, then press the **SET 0** key to enter the Set Mode.
2. Rotate the **DIAL** to select the Menu Item labeled (Measurements #6: ALTITUDE UNIT).
3. Press the **MAIN** or **SUB** key to select the preferred unit (m or ft).
4. Press the **PTT** key momentarily to save the new setting and exit to normal operation.

Measurements	:	7
ALTITUDE OFFSET		
ALT		m

Correcting the Altimeter Setting (Altimeter Offset)

1. Press the **MON F** key, then press the **SET 0** key to enter the Set Mode.
2. Rotate the **DIAL** to select the Menu Item labeled (Measurements #7: ALTITUDE OFFSET).
3. Press the **BAND DN** key to enable setting of this Menu Item.
4. Press the **TX P Q L K** key to indicate the altimeter data in “m” units.
5. Press the **MAIN** or **SUB** key to adjust the **VX-7R** display to the true altitude at your current location in “m” units.
6. Press the **WRITE MT** key to save the new setting.
7. Press the **PTT** key momentarily to exit to normal operation.

Measurements	:	7
ALTITUDE OFFSET		
ALT	024	m

TIMER OPERATION

The **VX-7R** includes the capability to turn itself on/off at preset time. If you use these features, you must first set the **VX-7R**'s clock, as described previously.

ON TIMER

1. Press the **(MONF)** key, then press the **(SET 0)** key to enter the Set mode.
2. Rotate the **DIAL** to select the Menu Item labeled (**Save Modes #5: ON TIMER**).
3. Press the **(BND DN BAND)** key to enable setting of this Menu Item.
4. Press the **(MAIN)** or **(SUB)** key to set the “*hour*” at which you want the radio to switch on.
5. Rotate the **DIAL** one click clockwise, then press the **(MAIN)** or **(SUB)** key to set the “*minute*” at which you want the radio to switch on.
6. Rotate the **DIAL** one click clockwise again, then press the **(MAIN)** or **(SUB)** key to set this Menu Item to “**ON**.”
7. Once you have made your selections, press the **PTT** key to save the new settings and exit to normal operation.

Save Modes	:	5
ON TIMER		
		0:00 OFF

OFF TIMER

1. Press the **(MONF)** key, then press the **(SET 0)** key to enter the Set mode.
2. Rotate the **DIAL** to select the Menu Item labeled (**Save Modes #6: OFF TIMER**).
3. Press the **(BND DN BAND)** key to enable setting of this Menu Item.
4. Press the **(MAIN)** or **(SUB)** key to set the “*hour*” at which you want the radio to switch off.
5. Rotate the **DIAL** one click clockwise, then press the **(MAIN)** or **(SUB)** key to set the “*minute*” at which you want the radio to switch off.
6. Rotate the **DIAL** one click clockwise again, then press the **(MAIN)** or **(SUB)** key to set this Menu Item to “**ON**.”
7. Once you have made your selections, press the **PTT** key to save the new settings and exit to normal operation.

Save Modes	:	6
OFF TIMER		
		0:00 OFF

downloaded by
www.radioamatore.info

DISPLAY CUSTOMIZATION

The **VX-7R**'s display includes several unique customization options which can expand your enjoyment of your transceiver.

ICON MODE

The display's alphanumeric labels can be replaced by pictorial icons, which may be easier to remember during operation.

To activate the Icon mode:

1. Press the **MON F** key, then press the **SET 0** key to enter the Set mode.
2. Rotate the **DIAL** to select the Menu Item labeled (**Misc Setup #12: ICON SET**).
3. Press the **MAIN** or **SUB** key to set this Menu Item to **ON**.
4. When you have made your selection, press the **PTT** to save the new setting and exit to normal operation.
5. The display will change to incorporate the default icons, as stored in the microprocessor's firmware.

Misc Setup	:12
ICON SET	
	OFF



The icon will be replaced by an alphanumeric label during dual band operation. You can, of course, individually select the display items which you wish to be represented by icons.

145.000
TIME 10:00
Main NFM

ICON SELECTION

1. Press the **MON F** key, then press the **SET 0** key to enter the Set Mode.
2. Rotate the **DIAL** to select the Menu Item labeled (**Misc Setup #14: ICON SELECT**).
3. Press the **BND DN BAND** key to enable modification of this Menu Item.
4. Press the **MAIN** or **SUB** key to select the desired band or mode on which you wish to utilize an Icon.
5. Turn the **DIAL** one click clockwise, then press the **MAIN** or **SUB** key to select the desired Icon to be displayed in place of the regular indicator.
6. Press the **PTT** key momentarily to save the new setting and exit to normal operation.

Misc Setup	:14
ICON SELECT	
MW	

ICON List

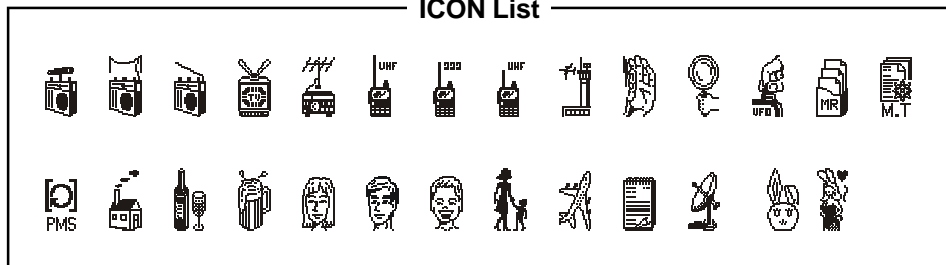

DISPLAY CUSTOMIZATION

ICON EDITOR

The **VX-7R** has three Icon memory channels which may be customized by the user. Using this feature, you may draw new Icons to be used in identifying features in a way easily recognizable by you.

1. Press the **MONF** key, then press the **SET** key to enter the Set Mode.
2. Rotate the **DIAL** to select the Menu Item labeled (**Misc Setup #13: ICON EDITOR**).
3. Press the **BAND** key to enable this Menu Item.
4. Press the **MAIN** or **SUB** key to select the desired Icon memory channel (**I1 - I3**).
5. A blinking dot will appear in the upper left corner of the icon field.
6. Press the **DW**, **UP**, **DOWN**, and **SP-ANA** key to move the dot to “*upward*,” “*downward*,” “*leftward*,” and “*rightward*” respectively. Bring the dot to desired point on the icon field, then press the **SCH** key to set a dot at this point. Continue moving the dot around the field, pressing **SCH** at each point where you wish a dot to appear (adjacent dots will have the effect of creating a line).
7. Turn the **DIAL** one click clockwise, then press the **MAIN** or **SUB** key to select the desired Icon to be displayed in place of the regular indicator.
8. Press the **PTT** key momentarily to save the new setting and exit to normal operation.

Misc Setup	:13
ICON EDITOR	
	OFF



Misc Setup	:13	
I1	<input type="checkbox"/>	<input type="checkbox"/>

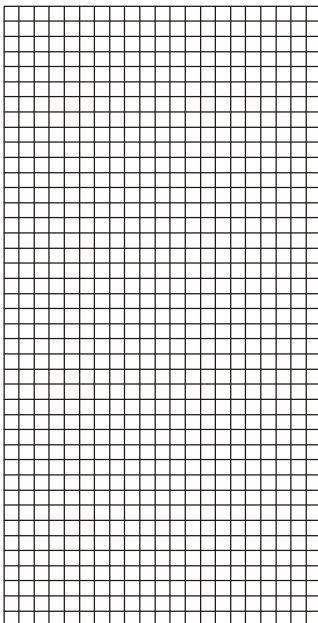

POWER-OFF DISPLAY MODE

When the **VX-7R** is turned off, the LCD may be set up to display one or more environmental measurements. These include temperature, barometric pressure, altitude, or combinations of these.

1. Press the **(MONF)** key, then press the **(SET)** key to enter the Set mode.
2. Rotate the **DIAL** to select the Menu Item labeled (Display Setup #4: DISPLAY MODE).
3. Press the **(MAIN)** or **(SUB)** key to select the new setting. The options include

Display Setup : 4 DISPLAY MODE TEMP

- NONE:** No display when the transceiver is off.
- TEMP:** Display of the current time plus temperature when the transceiver is off.
- BARO:** Display of the current time plus barometric pressure when the transceiver is off (requires optional **SU-1**).
- ALTI:** Display of the current time plus the current altitude when the transceiver is off (requires optional **SU-1**).
- TEMP+BARO:** Display of the current time, Temperature, and barometric pressure (requires optional **SU-1**).
- TEMP+ALTI:** Display of the current time, Temperature, and altitude (requires optional **SU-1**).
- ALL:** Display of the current time, temperature, barometric pressure, and altitude (requires optional **SU-1**).

Note: the current time will always be displayed when the transceiver is off, except when “**NONE**” is selected.

4. When you have made your selection, press the **PTT** key to save the new setting and exit to normal operation.



*If any of the above settings (except “**NONE**”) is enabled, the current drain with the **VX-7R** turned off will be about 20 mA. We recommend that the Power-Off Display Mode be set to “**NONE**” if you plan to be away from the radio for an extended period of time.*





DISPLAY CUSTOMIZATION

S-AND TX POWER METER SYMBOLS

The **VX-7R** has six types of S- (Signal Strength) and TX Power Meter symbol formats available. You may change the default setting to any of the available symbols.

1. Press the **MONI** key, then press the **SET** key to enter the Set mode.
2. Rotate the **DIAL** to select the Menu Item labeled (Display Setup #8: METER SYMBOL).
3. Press the **BND DN** key to enable modification of this Menu Item.
4. Press the **MAIN** or **SUB** key to select the desired meter symbol type.



- S1: 
- S2: 
- S3: 
- S4: 
- S5: 
- CHR:12345678

5. When you have made your selection, press the **PTT** key to save the new setting and exit to normal operation.



The S- and PO Meter Symbol may be changed to appear in the “Main” band and “Sub” band locations separately.

Modification of the Default the S-and TX Power Meter Symbol

The default “12345678” symbol which is used for last meter type may be replaced by several other symbols, if desired.

Here’s how to replace the default meter symbol:

1. Recall the last meter type, described previously.
2. Press the **BND DN** key to enable modification of this Menu Item.
3. Rotate the **DIAL** one click clockwise, then press the **MAIN**/**SUB** key or keypad to select the character in the first digit.

Example 1: Press the **MAIN** or **SUB** key to select any of 61 available characters (including letters, numbers, and special symbols).

Example 2: Press the **DW** key repeatedly to toggle among the seven available characters: **A → B → C → a → b → c → 2**

4. Rotate the **DIAL** to move to the next digit.
5. Repeat previous steps 3 and 4 as necessary to complete (up to 8 characters).
6. When you have made your choice, press the **BND DN** key, then press the **PTT** key to save your selection and exit to normal operation.



You can create an original font, as described in the next column.

FONT EDITOR

The **VX-7R** has five Font memory channels which may be created the user.

1. Press the **MON F** key, then press the **SET 0** key to enter the Set Mode.
2. Rotate the **DIAL** to select the Menu Item labeled (Misc Setup #11: FONT EDITOR).
3. Press the **BAND** key to enable this Menu Item.
4. Press the **MAIN** or **SUB** key to select the desired Font memory channel (C1 - C5).
5. A blinking dot will appear in the upper left corner of the font field.
6. Press the **DW**, **UP**, **DOWN**, and **SP-ANA** key to move the dot “upward,” “downward,” “leftward,” and “rightward” respectively. Bring the dot to the desired point on the font field, then press the **S.SCH** key to set a dot at this point. Continue moving the dot around the field, pressing **S.SCH** at each point where you wish a dot to appear (adjacent dots will have the effect of creating a line).
7. Turn the **DIAL** one click clockwise, then press the **MAIN** or **SUB** key to select the font to be displayed in place of the regular indicator.
8. Press the **PTT** key momentarily to save the new setting and exit to normal operation.

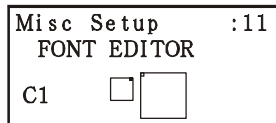

The original fonts also can be used for the alpha-numeric tag.

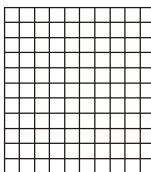

DISPLAY CUSTOMIZATION

DISPLAY CONTRAST

The LCD's contrast may be adjusted using the Menu, as well.

1. Press the **MONF** key, then press the **SET** key to enter the Set mode.
2. Rotate the **DIAL** to select the Menu Item labeled (**Display Setup #2: CONTRAST**).
3. Press the **MAIN** or **SUB** key to adjust the contrast. As you make the adjustment, you will be able to see the effects of your changes.
4. When you have completed the adjustment, press the **PTT** key to save the new setting and exit to normal operation.

Display Setup : 2 CONTRAST LEVEL 7
--

DISPLAY DIMMER

The LCD and keypad illumination may be adjusted using the Menu, as well.

1. Press the **MONF** key, then press the **SET** key to enter the Set mode.
2. Rotate the **DIAL** to select the Menu Item labeled (**Display Setup #3: DIMMER**).
3. Press the **MAIN** or **SUB** key to adjust the display illumination for a comfortable brightness level. As you make the adjustment, you will be able to see the effects of your changes.
4. When you have completed the adjustment, press the **PTT** key to save the new setting and exit to normal operation.

Display Setup : 3 DIMMER LEVEL 10

STROBE CUSTOMIZATION

The **VX-7R**'s **STROBE** also includes customization options.

COLOR Selection

1. Press the **MONF** key, then press the **SET** key to enter the Set Mode.
2. Rotate the **DIAL** to select the Menu Item labeled (**Display Setup #7: LED COLOR 2**).
3. Press the **BAND** key to enable modification of this Menu Item.
4. Press the **MAIN** or **SUB** key to select the desired band or status which you wish to utilize. Available selections are:

Display Setup : 7
LED COLOR 2
Main BUSY 1

Main BUSY: Sets the **STROBE** color displayed while the squelch is open on the "Main" band.

Sub BUSY: Sets the **STROBE** color displayed while the squelch is open on the "Sub" band.

DUAL BUSY: Sets the **STROBE** color displayed during Dual Receive operation.

Main TX: Sets the **STROBE** color displayed while transmitting on the "Main" band.

Sub TX: Sets the **STROBE** color displayed while transmitting on the "Sub" band.

CHG Complete: Set the **STROBE** color when battery charging is finished.

5. Turn the **DIAL** one click clockwise, then press the **MAIN** or **SUB** key to select the desired color to be illuminated in place of the regular color.
6. Press the **PTT** key momentarily to save the your new setting and exit to normal operation.

COLOR Editor

The exact color mix of the "**STROBE**"s" color selections may be adjusted, providing you with a custom-designed color hue. The Red, Green, and Blue elements of each color's composition may be adjusted individually.

1. Press the **MONF** key, then press the **SET** key to enter the Set Mode.
2. Rotate the **DIAL** to select the Menu Item labeled (**Display Setup #6: LED COLOR 1**).
3. Press the **BAND** key to enable modification of this Menu Item.
4. Press the **MAIN** or **SUB** key to select the desired color which you wish to edit.

Display Setup : 6
LED COLOR 1
LED 1 R G B

Turn the **DIAL** one click clockwise, then press the **MAIN** or **SUB** key to adjust the "R" (red) element of the color; you will be able to see the effects of your changes; the degree of color hue is designated in a numerical scale of **0** through **255**. If you press the **MONF** key, then press the **MAIN** or **SUB** key, you can now change the "R" element in 10-step increments, allowing very quick selection.





5. Repeat above step to adjust the "G" (Green) and "B" (Blue) elements of the color.
6. Press the **BAND** key to save the new setting, then press the **PTT** key to exit to normal operation.

RESET PROCEDURES

In some instances of erratic or unpredictable operation, the cause may be corruption of data in the microprocessor (due to static electricity, etc.). If this happens, resetting of the microprocessor may restore normal operation. Note that all memories will be erased if you do a complete microprocessor reset, as described below.



MICROPROCESSOR RESETTING

To clear all memories and other settings to factory defaults:

1. Turn the radio off.
 2. Press and hold in the , , and  keys while turning the radio on.
 3. Press the  key momentarily to reset all settings to their factory defaults (press any other key to cancel the Reset procedure).
-

SET MODE RESETTING

To reset the Set (Menu) mode settings to their factory defaults:

1. Turn the radio off.
2. Press and hold in the , and  keys while turning the radio on.
3. Press the  key momentarily to reset the Set (Menu) mode settings to their factory defaults (press any other key to cancel the Reset procedure).

The **VX-7R** includes a convenient “Clone” feature, which allows the memory and configuration data from one transceiver to be transferred to another **VX-7R**. This can be particularly useful when configuring a number of transceivers for a public service operation. Here is the procedure for Cloning one radio’s data to another:

1. Turn both radios off.
2. Connect the user-constructed cloning cable and two optional **CT-91** Microphone Adapters (one on each end) between the **MIC/SP** jacks of the two radios.
3. Press and hold in the **[MON F]** key while turning the radios on. Do this for both radios (the order of switch-on does not matter). “**CLONE**” will appear on the displays of both radios when the Clone mode is successfully activated in this step.
4. On the Destination radio, press the **[WRITE MT V/M]** key (“**CLONE WAIT**” will appear on the LCD).
5. Press the **[BAND DN BAND]** key on the Source radio; “**CLONE TX**” will appear on the Source radio, and the data from this radio will be transferred to the other radio.

(Source radio)
6. If there is a problem during the cloning process, “**CLONE ERROR**” will be displayed. Check your cable connections and battery voltage, and try again.
7. If the data transfer is successful, “**CLONE**” will reappear on both displays. Turn both radios off and disconnect the cloning cable and **CT-91**s. You can then turn the radios back on, and begin normal operation.

(Destination radio)

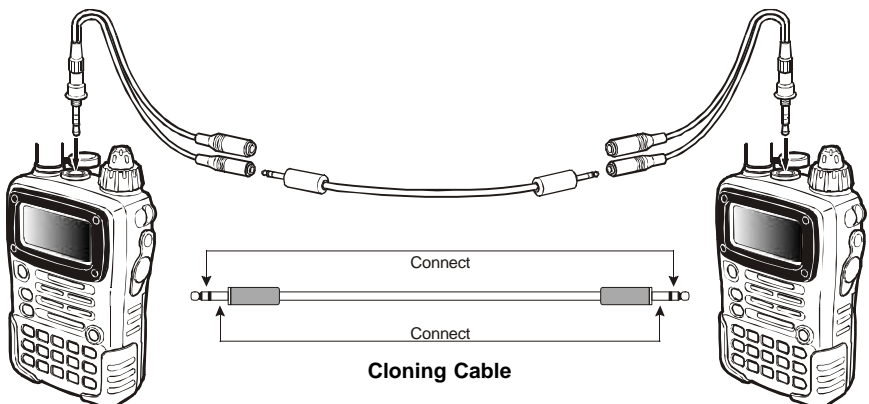

SET MODE

The **VX-7R** Set (Menu) mode, already described in parts of many previous chapters, is easy to activate and set. It may be used for configuration of a wide variety of transceiver parameters, some of which have not been detailed previously. Use the following procedure to activate the Set (Menu) mode:

1. Press the **[MONI]** key, then press the **[SET]** key to enter the Set mode.
2. Turn the **DIAL** to select the Menu Item to be adjusted.
3. Press the **[MAIN]** / **[SUB]** key to adjust or select the parameter to be changed on the Menu item selected in above step.
4. After completing your selection and adjustment, press the **PTT** switch momentarily to exit the Set mode and exit to normal operation.

 *Some Menu Items must be enabled for adjustment by pressing the **[BAND]** key before selecting the parameter to be adjusted.*

“MY MENU” Short-cut Key Setup

The **MY MENU** key function allows you to create a short-cut path for recall of one of Menu Items. The **[TX PO LK]** key then serves as the “Short-Cut” key.

1. **Press and hold in** the **[TX PO LK]** key while turning the radio on. This procedure switches the **[TX PO LK]** key between the “Internet Connection” function and the “**MY MENU**” key function.
2. Recall the Menu Item which you wish to assign to the **[TX PO LK]** key as a Menu short-cut.
3. Press and hold in the **[TX PO LK]** key for 1/2 second to assign the Menu Item to the **[TX PO LK]** key.

	Set Mode Item	Function	Available Values (Default: <i>Bold Italic</i>)
Basic Setup	#1 [SQL NFM]	Set the Squelch threshold level for the AM and FM-Narrow mode.	LEVEL 0 ~ LEVEL 15 (<i>LEVEL 1</i>)
	#2 [SQL WFM]	Set the Squelch threshold level for the FM-Wide mode.	LEVEL 0 ~ LEVEL 8 (<i>LEVEL 2</i>)
	#3 [VFO STEP]	Setting of the synthesizer steps.	5/9/10/12.5/15/20/25/50/100 kHz*1
	#4 [RX MODE]	Selects the Operating mode.	<i>AUTO</i> N-FM/AM/W-FM
	#5 [ARS]	Enables/disables the Automatic Repeater Shift function.	ON/OFF*1
	#6 [SHIFT]	Sets the magnitude of the Repeater Shift.	0.00 ~ 99.95 MHz*1
	#7 [RPT SHIFT]	Sets the Repeater Shift Direction.	-RPT/+RPT/SIMP*1
	#8 [MUTE SET]	Enables/disables the Audio Mute feature while using Dual Band reception.	ON/OFF
	#9 [KEY BEEP]	Enables/disables the Keypad beeper.	ON/OFF
	#10 [LOCK MODE]	Selects the Control Locking lockout combination.	KEY/DIAL/KEY+DIAL/PTT/ KEY+PTT/DIAL+PTT/ALL
	#11 [NAME SET]	Stores Alpha-Numeric “Tags” for the Memory channels.	-
#12 [MEMORY WRITE MODE]	Selects the method of selection of channels for Memory Storage.	<i>LOWER CH</i> /NEXT CH	
#13 [MEMORY SCAN MODE]	Selects what action will happen on a “flagged” Memory Channel.	OFF/SKIP/PREFERENTIAL	
#14 [HYPER WRITE]	Enables/disables the Hyper Memory Write feature.	<i>ENABLE</i> /DISABLE	
Display Setup	#1 [BUSY LED]	Enables/disables the BUSY LED (“STROBE”) while the Squelch is open.	ON/OFF
	#2 [CONTRAST]	Setting of the Display contrast level.	LEVEL 1 ~ LEVEL 10 (<i>LEVEL 7</i>)
	#3 [DIMMER]	Setting of the Display brightness level.	LEVEL 0 ~ LEVEL 12 (<i>LEVEL 10</i>)
	#4 [DISPLAY MODE]	Selects the display while the transceiver’s power is off.	<i>NONE</i> /TEMP/BARO/ALTI/ TEMP+BARO/TEMP+ALTI/ALL
	#5 [LAMP MODE]	Selects the LCD/Keypad Lamp mode.	KEY/CONTINUE/OFF
	#6 [LED COLOR 1]	Edits the “STROBE” color.	-
	#7 [LED COLOR 2]	Selects the “STROBE” color for each operating status.	-
	#8 [METER SYMBOL]	Selects the S- & TX PO meter Symbol.	S1/S2/S3/S4/S5/CHR

SET MODE

	Set Mode Item	Function	Available Values (Default: Bold Italic)
TSQ/DCS/DTMF	#1 [SQL TYPE]	Selects the Tone Encoder and/or Decoder mode.	OFFTONE/TONE SQL/DCS
	#2 [TONE SET]	Setting of the CTCSS Tone Frequency.	50 standard CTCSS tones (88.5 Hz)
	#3 [DCS SET]	Setting of the DCS code.	104 standard DCS codes (023)
	#4 [DCS COMPLEMENT]	Enables/Disables "Inverted" DCS code decoding.	ENABLE/ DISABLE
	#5 [BELL]	Selects the CTCSS Bell ringer repetitions.	OFF /1/3/5/8/CONTINUE
	#6 [SPLIT TONE]	Enables/disables split CTCSS/DCS coding.	OFF ON
	#7 [DTMF DIALER]	Enables/disables the DTMF Autodial feature.	ON/ OFF
	#8 [DTMF SET]	Programming of the DTMF Autodialer.	–
Scan Modes	#1 [CH COUNTER]	Selects the Channel Counter Search Width.	±5 MHz /±10 MHz/± 50 MHz/ ±100 MHz
	#2 [EDGE BEEP]	Enables/disables the Band-edge beeper while scanning.	ON/ OFF
	#3 [RESUME]	Selects the Scan Resume mode.	3SEC/ 5SEC /7SEC/10SEC/BUSY/ HOLD
	#4 [SCAN LAMP]	Enables/disables the Scan lamp while paused.	ON OFF
	#5 [SMART SEARCH]	Selects the Smart Search Sweep mode.	1/CONTINUOUS
	#6 [SPEC-ANALYZER 1]	Selects the Spectrum Analyzer Sweep mode.	1/CONTINUOUS
	#7 [SPEC-ANALYZER 2]	Enables/disables the audio output of the center frequency (▼) when the Spectrum Analyzer is activated in the Amateur band.	ON/ OFF
Measurement	#1 [SENSOR DISPLAY]	Selects the display of the sensor units's information.	TIME /DC/TEMP/WAVE/BARO* ² / ALTI* ² /WX* ² /OFF
	#2 [WAVE MONITOR]	Select the Wave Form to be monitored.	ALL /RX SIGNAL/TX MODULATION
	#3 [TEMP UNIT]	Selects the measurement units for the Temperature sensor.	°C/°F * ³
	#4 [BARO UNIT]	Selects the measurement units for the Barometric Pressure sensor* ² .	hpa/mbar/mmHg/inch * ³
	#5 [BARO OFFSET]	Correcting the Barometric Pressure* ² .	–
	#6 [ALTITUDE UNIT]	Select the measurement units for the Altimeter* ² .	m/ft * ³
	#7 [ALTITUDE OFFSET]	Correcting the Altimeter* ² .	–
Save Modes	#1 [APO]	Setting of the Automatic Power-Off time.	OFF /30 min/1 hour/3 hours/ 5 hours/8 hours
	#2 [RX SAVE]	Selects the Receive-mode Battery Saver interval ("sleep" ratio).	OFF/ 200mS (1:1)/300mS(1:1.5)/ 500mS(1:2.5)/1s(1:5)/2s(1:10)
	#3 [TX SAVE]	Enables/disables the Transmit Battery Saver.	ON/ OFF
	#4 [TOT]	Setting of the TOT time.	OFF /1 min/2.5 min/5 min/10 min
	#5 [ON TIMER]	Set the ON Timer time.	OFF /00:00 ~ 23:59
	#6 [OFF TIMER]	Set the OFF Timer time.	OFF /00:00 ~ 23:59
ARTS	#1 [ARTS BEEP]	Select the Beep option during ARTS operation.	IN RANGE /ALWAYS/OFF
	#2 [ARTS INTERVAL]	Select the Polling Interval during ARTS operation.	15 SEC /25 SEC
	#3 [CW ID]	Program and activate the CW Identifier (used during ARTS operation).	–
Misc Setup	#1 [BCLO]	Enables/disables the Busy Channel Lock-Out feature.	ON/ OFF
	#2 [HOME/REV]	Selects the function of the [HM/RV(EMG)] key.	HOME/ REV
	#3 [MON/T-CAL]	Selects the MONI key (just below the PTT switch) function.	MONI/T-CAL * ³
	#4 [MON-F CHANGE]	Exchange the functions between the [MON/F] key and the MONI keys on the left side of the radio.	FUNC /MONI
	#5 [EMG SET]	Select the alarms utilized when the Emergency function is engaged.	BEEP+STROBE /BEEP/ STROBE1/STROBE2/STROBE3/ STROBE4/ STROBE5/BEAM
	#6 [HALF DEVIATION]	Reducing the Deviation level by 50%.	ON/ OFF
	#7 [VOX SENS]	Enables/disables VOX operation; sets VOX sensitivity.	OFF /HIGH/LOW
	#8 [VOX DELAY]	Selects the VOX delay ("hang") time.	0.5S /1S/2S
	#9 [BAND LINK]	Enables/disables the BAND Link feature.	ON/ OFF
	#10 [VFO MODE]	Selects or disables the VFO Band edge for the current band.	ALL /BAND
	#11 [FONT EDITOR]	Editing of the User font.	–
	#12 [ICON SET]	Enables/disables the Icon display.	ON/ OFF
#13 [ICON EDITOR]	Editing of the User Icon.	–	
#14 [ICON SELECT]	ICON selection.	–	
#15 [CLOCK SHIFT]	Shifting of CPU clock frequency.	ON/ OFF	
#16 [TIME SET]	Sets the Clock time.	–	
#17 [LANGUAGE]	Selects the language for the Set (Menu) mode selections.	ENGLISH /JAPANESE	
#18 [ATT]	Enables/disables the Front-end Attenuator	ON/ OFF	
#19 [MIC MONITOR]	Enables/disables the Microphone Monitor feature.	ON/ OFF	
#20 [WX ALERT]	Enables/disables the Weather Alert Feature	ON/ OFF	

*1: Depends on the Frequency Band. *2: Requires optional **SU-1** *3: Depends on the Transceiver Version.

SET MODE

Basic Setup #1 [SQL NFM]

Function: Sets the Squelch threshold level for the AM and FM-Narrow modes.

Available Values: 0 ~ 15

Default: 1

Basic Setup #2 [SQL WFM]

Function: Sets the Squelch threshold level for the FM-Wide mode.

Available Values: 0 ~ 8

Default: 2

Basic Setup #3 [VFO STEP]

Function: Setting of the synthesizer steps.

Available Values: 5/9/10/12.5/15/20/25/50/100 kHz

Default: Depends on the transceiver version.

Basic Setup #4 [RX MODE]

Function: Selects the Operating mode.

Available Values: AUTO/N-FM/AM/W-FM

Default: AUTO (Mode automatically changes according to operating frequency)

Basic Setup #5 [ARS]

Function: Enables/disables the Automatic Repeater Shift function.

Available Values: ON/OFF

Default: ON

Basic Setup #6 [SHIFT]

Function: Sets the magnitude of the Repeater Shift.

Available Values: 0.00 ~ 99.95 MHz

Default: Depends on the transceiver version.

Basic Setup #7 [RPT SHIFT]

Function: Sets the Repeater Shift Direction

Available Values: +RPT/+RPT/SIMP

Default: Depends on the transceiver version.

Basic Setup #8 [MUTE SET]

Function: Enables/disables the Audio Mute feature while using Dual Band reception.

Available Values: ON/OFF

Default: OFF

Basic Setup #9 [KEY BEEP]

Function: Enables/disables the Keypad beeper.

Available Values: ON/OFF

Default: ON

Basic Setup #10 [LOCK MODE]

Function: Selects the Control Locking lockout combination.

Available Values: KEY/DIAL/KEY+DIAL/PTT/KEY+PTT/DIAL+PTT/ALL

Default: KEY

Basic Setup #11 [NAME SET]

Function: Stores Alpha-Numeric “Tags” for the Memory channels. See page 48 for details.

Basic Setup #12 [MEMORY WRITE MODE]

Function: Selects the method of selection of channels for Memory Storage.

Available Values: LOWER CH/NEXT CH

Default: LOWER CH

LOWER CH: Stores in the next-available “free” channel

NEXT CH: Store in the memory channel which is next-highest from the last-stored memory channel.

Basic Setup #13 [MEMORY SCAN MODE]

Function: Selects what action will happen on a “flagged” Memory Channel.

Available Values: OFF/SKIP/PREFERENTIAL

Default: OFF

SKIP: The scanner will “skip” the flagged channels during scanning.

PREFERENTIAL: The scanner will only scan channels that are flagged (Preferential Scan List).

Basic Setup #14 [HYPER WRITE]

Function: Enables/disables the Hyper Memory Write feature

Available Values: ENABLE/DISABLE

Default: ENABLE

Display Setup #1 [BUSY LED]

Function: Enables/disables the BUSY LED (“STROBE”) while the Squelch is open.

Available Values: ON/OFF

Default: ON (“STROBE” lights up when the Squelch is open)

Display Setup #2 [CONTRAST]

Function: Setting of the Display contrast level.

Available Values: 1 ~ 10

Default: 7

Display Setup #3 [DIMMER]

Function: Setting of the Display brightness level.

Available Values: 1 ~ 12

Default: 10

SET MODE

Display Setup #4 [DISPLAY MODE]

Function: Selects the display while the transceiver's power is off

Available Values: NONE/TEMP/BARO/ALTI/TEMP+BARO/TEMP+ALTI/ALL

Default: NONE

- NONE: No display when the transceiver is off.
- TEMP: Display of the current time plus temperature when the transceiver is off.
- BARO: Display of the current time plus barometric pressure when the transceiver is off (requires optional SU-1).
- ALTI: Display of the current time plus the current altitude when the transceiver is off (requires optional SU-1).
- TEMP+BARO: Display of the current time, Temperature, and barometric pressure.
- TEMP+ALTI: Display of the current time, Temperature, and altitude.
- ALL: Display of the current time, temperature, barometric pressure, and altitude.



1) The current time will always be displayed when the transceiver is off, except when "NONE" is selected.

2) The barometric pressure and altitude information require the optional SU-1.

Display Setup #5 [LAMP MODE]

Function: Selects the LCD/Keypad Lamp mode.

Available Values: KEY /CONTINUE/OFF

Default: KEY

- KEY: Illuminates the LCD/Keypad for 5 seconds when any key is pressed.
- CONTINUE: Pressing the LAMP key toggles LCD/Keypad lamp On/Off.
- OFF: Disables the LCD/Keypad Lamp.

Display Setup #6 [LED COLOR 1]

Function: Edits the "STROBE" color.

Individual adjustments of the Red, Green, and Blue color hue may be performed, on a numerical scale of 0 to 255. See page 79 for details.

LED No.	Default			
	COLOR	R	G	B
1	Green	0	45	0
2	Blue	0	0	48
3	Orange	57	46	0
4	Red	51	0	0
5	Purple	50	0	44
6	Sky Blue	0	42	44
7	Yellow Green	47	44	0
8	Milky White	50	43	44
9	Violet	50	0	49
0	White	255	255	255

Display Setup #7 [LED COLOR 2]

Function: Selects the “STROBE” color for each operating status.

Main BUSY: Sets the STROBE color displayed while the squelch is open on the “Main” band (Default: 1).

Sub BUSY: Sets the STROBE color displayed while the squelch is open on the “Sub” band (Default: 2).



DUAL BUSY: Sets the STROBE color displayed during Dual Receive operation (Default: 3).

Main TX: Sets the STROBE color displayed while transmitting on the “Main” band (Default: 4).

Sub TX: Sets the STROBE color displayed while transmitting on the “Sub” band (Default: 5).

CHG Complete: Set the STROBE color displayed when battery charging is finished (Default: 2).



In this mode, press the  key to enable the setting of the “STROBE” color, and press the  key again to exit from this item. See page 79 for details.

Display Setup #8 [METER SYMBOL]

Function: Selects the S- & TX PO meter Symbol.

Available Values: Six patterns

S1: 

S2: 

S3: 

S4: 

S5: 

CHR: 12345678

Default: S1: 

The default “12345678” symbol which is used for last meter type may be replaced by several other symbols. See page 76 for details.

TSQ/DCS/DTMF #1 [SQL TYPE]

Function: Selects the Tone Encoder and/or Decoder mode.

Available Values: OFF/TONE/TONE SQL/DCS

Default: OFF

TONE: CTCSS Encoder

TONE SQL: CTCSS Encoder/Decoder

DCS: Digital Coded Squelch Encoder/Decoder

SET MODE



TSQ/DCS/DTMF #2 [TONE SET]

Function: Setting of the CTCSS Tone Frequency

Available Values: 50 standard CTCSS tones

Default: 100.0 Hz



In this mode, press the  key to enable the setting of the tone, and press the  key again to exit from this item.

CTCSS TONE FREQUENCY (Hz)					
67.0	69.3	71.9	74.4	77.0	79.7
82.5	85.4	88.5	91.5	94.8	97.4
100.0	103.5	107.2	110.9	114.8	118.8
123.0	127.3	131.8	136.5	141.3	146.2
151.4	156.7	159.8	162.2	165.5	167.9
171.3	173.8	177.3	179.9	183.5	186.2
189.9	192.8	196.6	199.5	203.5	206.5
210.7	218.1	225.7	229.1	233.6	241.8
250.3	254.1	-	-	-	-



TSQ/DCS/DTMF #3 [DCS SET]

Function: Setting of the DCS code.

Available Values: 104 standard DCS codes.

Default: 023



In this mode, press the  key to enable the setting of the DCS code, and press the  key again to exit from this item.

DCS CODE									
023	025	026	031	032	036	043	047	051	053
054	065	071	072	073	074	114	115	116	122
125	131	132	134	143	145	152	155	156	162
165	172	174	205	212	223	225	226	243	244
245	246	251	252	255	261	263	265	266	271
274	306	311	315	325	331	332	343	346	351
356	364	365	371	411	412	413	423	431	432
445	446	452	454	455	462	464	465	466	503
506	516	523	526	532	546	565	606	612	624
627	631	632	654	662	664	703	712	723	731
732	734	743	754	-	-	-	-	-	-

TSQ/DCS/DTMF #4 [DCS COMPLEMENT]

Function: Enables/Disables “Inverted” DCS code decoding.

Available Values: ENABLE/DISABLE

Default: DISABLE

TSQ/DCS/DTMF #5 [BELL]

Function: Selects the CTCSS Bell ringer repetitions.

Available Values: OFF/1/3/5/8/CONTINUE

Default: OFF

TSQ/DCS/DTMF #6 [SPLIT TONE]

Function: Enables/disables split CTCSS/DCS coding.

Available Values: OFF/ON

Default: OFF

When this Menu Item is set to ON, you can see the following additional parameters after the “DCS” parameter while selecting the Menu Item (TSQ/DCS/DTMF #1: SQL TYPE),:

D CODE: DCS Encode only (“**D**” icon will appear while operating)

TONE DC: Encodes a CTCSS Tone and Decodes a DCS code
(the “**T ■ D**” icon will appear during operation)

DC TONE: Encodes a DCS code and Decodes a CTCSS Tone
(the “**D ■ T**” icon will appear during operation)

Select the desired operating mode from the selections shown above.

TSQ/DCS/DTMF #7 [DTMF DIALER]

Function: Enables/disables the DTMF Autodial feature.

Available Values: ON/OFF

Default: OFF

TSQ/DCS/DTMF #8 [DTMF SET]

Function: Programming of the DTMF Autodialer. See page 38 for details.

Scan Modes #1 [CH COUNTER]

Function: Selects the Channel Counter Search Width.

Available Values: ± 5 MHz/ ± 10 MHz/ ± 50 MHz/ ± 100 MHz

Default: ± 5 MHz

Scan Modes #2 [EDGE BEEP]

Function: Enables/disables the Band-edge beeper while selecting the frequency by the **DIAL**.

Available Values: ON/OFF

Default: OFF

When this Menu Item is set to “ON,” a beep will sound when the frequency reaches the band edge while selecting the VFO frequency by the **DIAL**.

SET MODE

Scan Modes #3 [RESUME]

Function: Selects the Scan Resume mode.

Available Values: 3SEC/5SEC/7SEC/10SEC/BUSY/HOLD

Default: 5 SEC

3SEC/5SEC/7SEC/10SEC: The scanner will hold for the selected period (seconds), then resume whether or not the other station is still transmitting.

BUSY: The scanner will hold until the signal disappears, then will resume when the carrier drops.

HOLD: The scanner will stop when a signal is received, and will not restart.

Scan Modes #4 [SCAN LAMP]

Function: Enables/disables the Scan lamp while paused.

Available Values: ON/OFF

Default: ON

Scan Modes #5 [SMART SEARCH]

Function: Selects the Smart Search Sweep mode.

Available Values: 1/CONTINUOUS

Default: 1

1: The transceiver sweeps the current band once in each direction starting on the current frequency. All channels where activity is present (up to 15 in each direction) are loaded into the Smart Search memories. Whether or not all 31 memories are filled, the search stops after one sweep in each direction.

CONTINUOUS: The transceiver makes a sweep in each direction as with the “1(SINGLE)” mode, but if all 31 channels are not filled after the first sweep, the radio continues sweeping until they are all filled.

Scan Modes #6 [SPEC-ANALYZER 1]

Function: Selects the Spectrum Analyzer Sweep mode.

Available Values: 1/CONTINUOUS

Default: 1

1: The transceiver sweeps the current band once.

CONTINUOUS: The transceiver sweeps the current band repeatedly until the Spectrum Analyzer is turned off

Scan Modes #7 [SPEC-ANALYZER 2]

Function: Enables/disables the audio output of the center frequency (▼) when the Spectrum Analyzer is activated in the Amateur band.

Available Values: ON/OFF

Default: OFF

Measurement #1 [SENSOR DISPLAY]

Function: Selects the display of the sensor units' information.

Available Values: TIME/DC/TEMP/WAVE/BARO/ALTI/WX/OFF

Default: TIME



The barometric pressure (BARO), altitude (ALTI), and Weather (WX) information require the optional SU-1.

Measurement #2 [WAVE MONITOR]

Function: Select the Wave Form to be monitored.

Available Values: ALL/RX SIGNAL/TX MODULATION

Default: ALL

ALL: Indicates the RX Audio wave form and TX Audio modulation wave form.

RX SIGNAL: Indicates the RX Audio modulation wave form.

TX MODULATION: Indicates the TX Audio modulation wave form.

Measurement #3 [TEMP UNIT]

Function: Selects the measurement units for the Temperature sensor.

Available Values: °C/°F

Default: Depends on the transceiver version

Measurement #4 [BARO UNIT]

Function: Selects the measurement units for the Barometric Pressure sensor (requires optional **SU-1**).

Available Values: hpa/mbar/mmHg/inch

Default: Depends on the transceiver version

Measurement #5 [BARO OFFSET]

Function: Correcting the Barometric Pressure (requires optional **SU-1**). See page 70 for details.

Measurement #6 [ALTITUDE UNIT]

Function: Select the measurement units for the Altimeter (requires optional **SU-1**).

Available Values: m/ft

Default: Depends on the transceiver version

Measurement #7 [ALTITUDE OFFSET]

Function: Correcting the Altimeter (requires optional **SU-1**). See page 71 for details.

Save Modes #1 [APO]

Function: Setting of the Automatic Power-Off time.

Available Values: OFF/30 min/1 hour/3 hours/5 hours/8 hours

Default: OFF

SET MODE

Save Modes #2 [RX SAVE]

Function: Selects the Receive-mode Battery Saver interval (“sleep” ratio).

Available Values: OFF/200mS(1:1)/300mS(1:1.5)/500mS(1:2.5)/1s(1:5)/2s(1:10)

Default: 200mS(1:1)

Save Modes #3 [TX SAVE]

Function: Enables/disables the Transmit Battery Saver.

Available Values: ON/OFF

Default: OFF

Save Modes #4 [TOT]

Function: Setting of the TOT time.

Available Values: OFF/1 min/2.5 min/5 min/10 min

Default: OFF

The time-out timer shuts off the transmitter after continuous transmission of the programmed time.

Save Modes #5 [ON TIMER]

Function: Set the ON Timer time.

Available Values: OFF/00:00 ~ 23:59

Default: OFF

The ON Timer turns on the radio at the programmed time.

Save Modes #6 [OFF TIMER]

Function: Set the OFF Timer time.

Available Values: OFF/00:00 ~ 23:59

Default: OFF

The OFF Timer turns off the radio at the programmed time.

ARTS #1 [ARTS BEEP]

Function: Select the Beep option during ARTS operation.

Available Values: IN RANGE/ALWAYS/OFF

Default: IN RANGE

RANGE: Beeps sound only when the radio first detects that you are within range.

ALWAYS: Beeps sound every time a polling transmission is received from the other station (every 15 or 25 seconds when in range).

OFF: No alert beeps sound.

ARTS #2 [ARTS INTERVAL]

Function: Select the Polling Interval during ARTS operation.

Available Values: 15 SEC/25 SEC

Default: 25 SEC

This setting determines how often the other station will be polled during ARTS operation.

ARTS #3 [CW ID]

Function: Program and activate the CW Identifier (used during ARTS operation). See page 37 for details.

Misc Setup #1 [BCLO]

Function: Enables/disables the Busy Channel Lock-Out feature.

Available Values: ON/OFF

Default: OFF

Misc Setup #2 [HOME/REV]

Function: Selects the function of the  key.

Available Values: HOME/REV

Default: Depends on the transceiver version.

HOME: Pressing this key instantly recalls a favorite “Home” channel.

REV: Pressing this key reverses the transmit and receive frequencies during repeater operation.

Misc Setup #3 [MONI/T-CAL]

Function: Selects the **MONI** key (just below the **PTT** switch) function.

Available Values: MONI/T-CAL

Default: Depends on the transceiver version.

MONI: Pressing the **MONI** key causes the Noise/Tone Squelch to be over-ridden, allowing you to listen for weak (or non-encoded) signals.

T-CAL: Pressing the **MONI** key activates a 1750-Hz burst tone, used for repeater access in many countries.

downloaded by
www.radioamatore.info



SET MODE

Misc Setup #4 [MON-F CHANGE]

Function: Exchange the functions between the  key and the **MONI** keys on the left side of the radio.

Available Values: FUNC/MONI



Default: FUNC

FUNC: The  key is defined as the “Alternate” function key. *Press* the  key to activate the “Secondary” key mode. Meanwhile, the **MONI** key is defined as the “Monitor” function, which overrides the Noise and Tone Squelch quieting systems.

MONI: The  key is defined as the “Monitor” function, which overrides the Noise and Tone Squelch quieting systems. Meanwhile, the **MONI** key is defined as the “Alternate” function key. The “Secondary” key mode is activated *while pressing and holding in* the **MONI** key.

Important Note: When you define the left side of the **MONI** key to be the “Alternate” function (“MONI” selected), the “Alternate” function is activated *while pressing and holding in* the **MONI** key, **NOT** by pressing and holding in the **MONI** key for 2 second.

Example:

- (1) To enter the Set mode, press the  key *while pressing and holding in* the **MONI** key.
- (2) To store a frequency into a memory channel.
 1. Select the desired frequency.
 2. Press the  key *while pressing and holding in* the **MONI** key.
 3. Rotate the **DIAL** to select the desired memory channel, as desired.
 4. Press the  key to store the frequency into the selected memory.

Misc Setup #5 [EMG SET]

Function: Select the alarms utilized when the Emergency function is engaged.

Available Values: BEEP+STROBE/BEEP/STROBE1/STROBE2/STROBE3/STROBE4/STROBE5/BEAM

Default: BEEP+STROBE

BEEP+STROBE:

Loud “Alarm” sounds along with flashing of the **STROBE** in sequential colors.

BEEP:

Loud “Alarm” sounds.

STROBE1:

Flashes the **STROBE** in sequential colors.

STROBE2:

Continuation changes the **STROBE** in sequential colors.

STROBE3, STROBE4, & STROBE5: Flashes the **STROBE** in white (3: Slow flashing, 4: Medium flashing, 5: Rapid flashing)

BEAM:

The **STROBE** glows continuously in white.

Misc Setup #6 [HALF DEVIATION]

Function: Reducing the Deviation level by 50%.

Available Values: ON/OFF

Default: OFF

Misc Setup #7 [VOX SENS]

Function: Enables/disables VOX operation; sets VOX sensitivity.

Available Values: OFF/HIGH/LOW

Default: OFF

Misc Setup #8 [VOX DELAY]

Function: Selects the VOX delay (“hang”) time.

Available Values: 0.5S/1S/2S

Default: 0.5S

Misc Setup #9 [BAND LINK]

Function: Enables/disables the BAND Link feature.

Available Values: ON/OFF

Default: OFF

When this feature is set to “ON,” the “Main” and “Sus” bands are “slaved” so that they change frequency together.

Misc Setup #10 [VFO MODE]

Function: Selects or disables the VFO Band edge for the current band.

Available Values: ALL/BAND

Default: BAND

ALL: When the VFO frequency reaches the high edge of the current band, the VFO frequency will jump to the low band edge of the *next band* (or vice versa).

BAND: When the VFO frequency reaches the high band edge of the current band, the VFO frequency will jump to the low band edge of the *current band* (or vice versa).

Misc Setup #11 [FONT EDITOR]

Function: Editing of the User font. See page 77 for details.

Misc Setup #12 [ICON SET]

Function: Enables/disables the Icon display.

Available Values: ON/OFF

Default: OFF

Misc Setup #13 [ICON EDITOR]

Function: Editing of the User Icon. See page 74 for details.

Misc Setup #14 [ICON SELECT]

Function: ICON selection. See page 73 for details.

SET MODE

Misc Setup #15 [CLOCK SHIFT]

Function: Shifting of CPU clock frequency.

Available Values: ON/OFF

Default: OFF

This function is only used to move a spurious response “birdie,” should it fall on a desired frequency.

Misc Setup #16 [TIME SET]

Function: Sets the Clock time. See page 69 for details.

Misc Setup #17 [LANGUAGE]

Function: Selects the language for the Set (Menu) mode selections.

Available Values: ENGLISH/JAPANESE

Default: ENGLISH

Misc Setup #18 [ATT]

Function: Enables/disables the Front-end Attenuator.

Available Values: ON/OFF

Default: OFF

Misc Setup #19 [MIC MONITOR]

Function: Enables/disables the Microphone Monitor feature.

Available Values: ON/OFF

Default: OFF

Misc Setup #20 [WX ALERT]

Function: Enables/disables the Weather Alert Feature

Available Values: ON/OFF

Default: OFF

downloaded by
www.radioamatore.info

INSTALLATION OF THE **SU-1** (OPTION)

1. Make sure that the transceiver is off. Remove the hard or soft case, if used.
2. Remove the battery pack.
3. Locate the connector for the **SU-1** under the caution seal in the battery compartment on the back of the radio, just peel off the caution seal.
4. Align the connector on the **SU-1** with the transceiver's connector and gently press the unit into place.
5. Affix the new (supplied) caution seal, and replace the battery.
6. Installation is now complete.

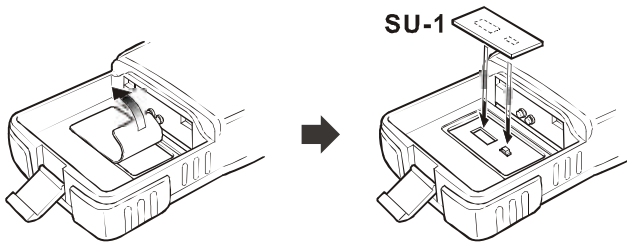

Important note

The Barometric Pressure/Altitude features of the optional **SU-1** are designed to be supplemental aids for the information of the user, and are not intended to be a substitute for accurate, calibrated Barometer or Altimeter devices used for navigation critical to personal safety.

SPECIFICATIONS

General

Frequency Ranges: MAIN Rx: 05-1.8 MHz (BC Band)
1.8-30 MHz (SW Band)
30-59 MHz (50 MHz HAM: USA version)
30-76 MHz (50 MHz HAM: EXP version)
59-108 MHz (FM: USA version)
76-108 MHz (FM: EXP version)
108-137 MHz (Air Band)
137-174 MHz (144 MHz HAM)
174-222 MHz (VHF-TV)
222-225 MHz (220 MHz HAM: USA version)
225-420 MHz (ACT1: Action Band 1: USA version)
222-420 MHz (ACT1: Action Band 1: EXP version)
420-470 MHz (430 MHz HAM)
470-729 MHz (UHF-TV: USA version)
470-800 MHz (UHF-TV: EXP version)
800-999 MHz (ACT2: Action Band 2, cellular Blocked)

SUB Rx: 50-54 MHz
137-174 MHz
420-470 MHz
Tx: 50-54 MHz (MAIN & SUB)
144-146 MHz or 144-148 MHz (MAIN & SUB)
222-225 MHz ((MAIN, USA version)
430-440 MHz or 430-450 MHz (MAIN & SUB)

Channel Steps: 5/9/10/12.5/15/20/25/50/100 kHz

Emission Type: F2, F3, A3

Frequency Stability: ± 5 ppm (-10 °C to $+50$ °C [$+14$ °F to $+122$ °F])

Repeater Shift: ± 600 kHz (144 MHz), ± 1.6 MHz (222 MHz), $\pm 1.6/5.0/7.6$ MHz (430 MHz)

Emission Type: A3/F2/F3

Antenna Impedance: 50 Ohms

Supply Voltage: Nominal: 7.4 V DC, Negative Ground

Operating: 10-16 V DC, Negative Ground (EXT DC jack)

Current Consumption: 200 mA (Mono Band Receive)

(Approx.) 240 mA (Dual Band Receive)

67 mA (Mono Band Receive, Standby, Saver Off)

100 mA (Dual Band Receive, Standby, Saver Off)

28 mA (Mono Band Receive, Standby, Saver On "Save Ratio 1:5")

34 mA (Dual Band Receive, Standby, Saver On "Save Ratio 1:5")

200 μ A (Auto Power Off)

1.6 A (50 MHz, 5 W Tx)

1.7A (144 MHz, 5W Tx)

1.0 A (220 MHz, 0.3 W Tx)

1.9 A (430 MHz, 5W Tx)

Operating Temperature: -20 °C to $+60$ °C (-4 °F to $+140$ °F)

Case Size (W x H x D): 60 x 90 x 28.5 mm (2.4 x 3.5 x 1.1 inch) w/o knob & antenna

Weight (Approx.): 260 g (9.2 oz) with FNB-80LI & antenna

Transmitter

- RF Power Output:** 5.0 W (@7.4 V & 13.8 V EXT DC IN)
0.3W (@7.4 V & 13.8 V EXT DC IN, 222 MHz)
1.0W (@7.4 V & 13.8 V EXT DC IN, 50 MHz AM)
- Modulation Type:** F2, F3: Variable Reactance (MAIN & SUB)
A3: Low Level Amplitude Modulation (MAIN, 50 MHz)
- Maximum Deviation:** ± 5 kHz F2/F3
- Spurious Emission:** At least 60 dB down (@ Tx HI/L3)
At least 50 dB down (@ Tx L2/L1)

Microphone Impedance: 2K Ohms

Receiver

- Circuit Type:** N-FM, AM: Double-Conversion Superheterodyne
W-FM: Triple-Conversion Superheterodyne
- IF:** MAIN Rx
1st: 47.25 MHz (N-FM, AM), 45.8 MHz (W-FM)
2nd: 450 kHz (N-FM, AM), 10.7 MHz (W-FM)
3rd: 1 MHz (W-FM)
SUB Rx
1st: 46.35 MHz
2nd: 450 kHz
- Sensitivity:** MAIN Rx:
3.0 μ V for 10 dB S/N (0.5-30 MHz, AM)
0.5 μ V (TYP) for 12 dB SINAD (30-50, N-FM)
0.16 μ V for 12 dB SINAD (50-54, N-FM)
1.0 μ V (TYP) for 12 dB SINAD (57-76, N-FM)
1.0 μ V (TYP) for 12 dB SINAD (76-108, W-FM)
1.5 μ V (TYP) for 10 dB SN (108-137, AM)
0.2 μ V for 12 dB SINAD (137-140, N-FM)
0.16 μ V for 12 dB SINAD (140-150, N-FM)
0.2 μ V for 12 dB SINAD (150-174, N-FM)
0.3 μ V for 12 dB SINAD (174-225, N-FM)
0.5 μ V for 12 dB SINAD (300-350, N-FM)
0.2 μ V for 12 dB SINAD (350-400, N-FM)
0.18 μ V for 12 dB SINAD (400-470, N-FM)
0.35 μ V for 12 dB SINAD (470-540, W-FM)
3.0 μ V (TYP) for 12 dB SINAD (540-800, W-FM)
1.0 μ V (TYP) for 12 dB SINAD (800-999, N-FM) (Cellular Blocked)
- SUB Rx:
0.18 μ V for 12 dB SINAD (50-54, N-FM)
0.18 μ V for 12 dB SINAD (137-174, N-FM)
0.2 μ V for 12 dB SINAD (420-470, N-FM)
- Selectivity:** 12 kHz/25 kHz (-6dB/-60dB: N-FM, AM)
200 kHz/300 kHz (-6dB/-20dB: W-FM)
- AF Output:** 200 mW @ 8 Ohms for 10 % THD (@ 7.4 V DC)
400 mW @ 8 Ohms for 10 % THD (@ 13.8 V DC)

Specifications are subject to change without notice, and are guaranteed within the 50/144/222/430 MHz amateur bands only.

APPENDIX

USING YOUR VX-7R FOR LOW-EARTH-ORBIT FM SATELLITE COMMUNICATION

Several Low-Earth-Orbit satellites, such as UO-14 and AO-27, utilize a single-channel FM “repeater in the sky” transponder, affording low-power stations the opportunity to make contacts with other stations thousands of miles away. Communication generally is most easily possible when using a hand-held transceiver (like the **VX-7R**) in conjunction with a small beam antenna, so as to improve your uplink signal.

Because the satellites are moving rapidly, you must compensate for Doppler Shift on the satellite signal. This is best accomplished by utilizing five “split” memory channels, covering sufficient frequency combinations, on the 144 and 430 MHz bands, to allow complete frequency coverage with quick selection.

Example: Set up for operation on UO-14’s transponder:

Set up your **VX-7R** with five “odd split” memories as shown at the right, to compensate for Doppler Shift:

CH #	Rx FREQ	Tx FREQ	NOTES
1	435.080 MHz	145.9700 MHz	AOS
2	435.075 MHz	145.9725 MHz	
3	435.070 MHz	145.9750 MHz	Mid Pass
4	435.065 MHz	145.9775 MHz	
5	435.060 MHz	145.9800 MHz	LOS

At the start of the pass, set to Channel 1. As the pass progresses, rotate the channel selector to choose the channel with the best downlink signal. The satellite moves fast

AOS = Acquisition of Signal (Beginning of Pass)

LOS = Loss of Signal (End of Pass)

(the optimum channel will change every three minutes!) so be alert. Keep calls short, as much of your continent will be calling on a single FM channel!

More information on UO-14 and other satellites may be found on the Web site of the Amateur Satellite Corporation: www.amsat.org (or on other satellite-based Web sites).

downloaded by
www.radioamatore.info

downloaded by
www.radioamatore.info

1. Changes or modifications to this device not expressly approved by VERTEX STANDARD could void the user's authorization to operate this device.
2. This device complies with part 15 of the FCC Rules. Operation is subject to the following two conditions; (1) this device may not cause harmful interference, and (2) this device must accept any interference including interference that may cause undesired operation.
3. The scanning receiver in this equipment is incapable of tuning, or readily being altered, by the User to operate within the frequency bands allocated to the Domestic public Cellular Telecommunications Service in Part 22.

This device complies with RSS-210 of Industry Canada. Operation is subject to the following two conditions; (1) this device may not cause interference, and (2) this device must accept any interference, including interference that may cause undesirable operation of the device.

WARNING: MODIFICATION OF THIS DEVICE TO RECEIVE CELLULAR RADIOTELEPHONE SERVICE SIGNALS IS PROHIBITED UNDER FCC RULES AND FEDERAL LAW.



downloaded by
www.radioamatore.info

Copyright 2002
VERTEX STANDARD CO., LTD.
All rights reserved.

Printed in Japan

No portion of this manual
may be reproduced
without the permission of
VERTEX STANDARD CO., LTD.



0204L-AY